

New York State Geological Association

Department of Geology
Colgate University

Meeting Number 64
September 19-20, 1992

Adirondack Field Trips

Trip AB-1

Geological Relationships of the Anorthosite-
Mangerite-Charnockite-Granite (AMCG) Suite and
Related Ore Deposits

James McLelland, Colgate University

Trip AB-2

Precambrian Geology of the Ausable Forks
Quadrangle, Northeastern Adirondacks

Philip Whitney, New York Geological Survey, and
James Olmsted, SUNY College at Plattsburgh

Trip AB-1

Geological Relationships of the Anorthosite- Mangerite-Charnockite-Granite (AMCG) Suite and Related Ore Deposits

James McLelland
Colgate University

INTRODUCTION AND GEOCHRONOLOGY

The Adirondacks form a southwestern extension of the Grenville Province (fig. 1) and have been physiographically divided into the Adirondack Highlands (granulite facies) and Lowlands (amphibolite facies) by a broad zone of high strain referred to as the Carthage-Colton Mylonite Zone (figs. 2,3) which is continuous with the Chibougamau-Gatineau line (AB on fig. 1). Together these two zones separate the Grenville Province into two major blocks with the Central Granulite Terrane (CGT) lying east of AB and the Central Metasedimentary Belt (CMB) and Central Gneiss Belt (CGB) lying to the west. Within the southwestern portion of the Grenville Province further subdivisions exist and are shown in figure 3.

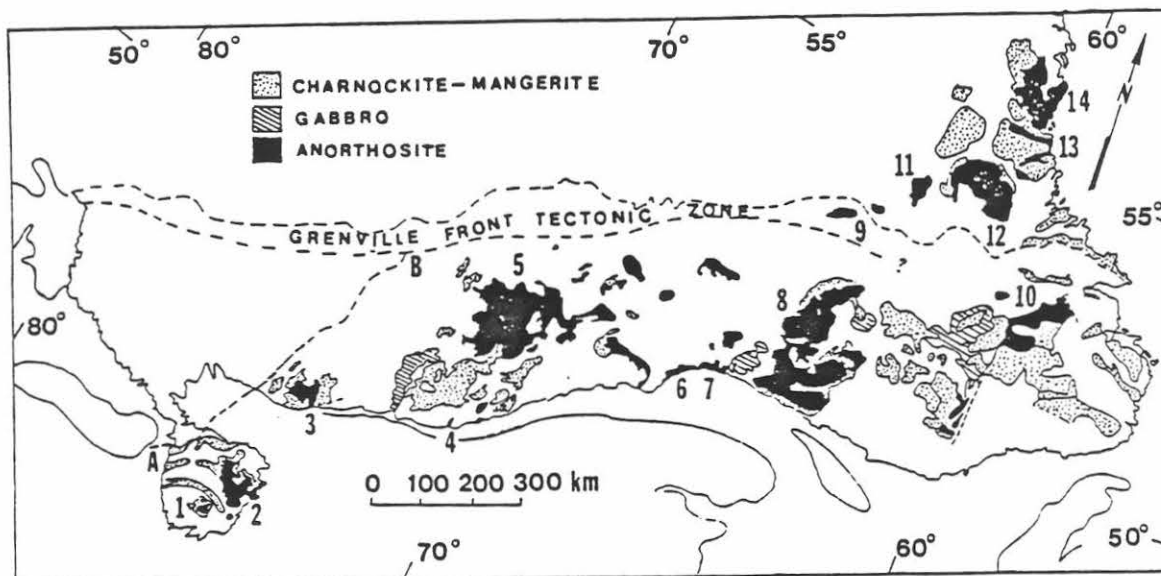

Fig. 1. Generalized map of anorthositic massifs within the Grenville Province and adjacent Labrador. The dashed line, AB, separates terranes with anorthosite massifs on the east from ones lacking them on the west and corresponds to the Carthage-Colton-Gatineau-Chibougamau Line. 1-Snowy Mt. and Oregon domes (ca. 1130 Ma); 2-Marcy massif (ca. 1135 Ma); 3-Morin anorthosite and Lac Croche complex (1160 ± 7 Ma); 4-St. Urbain anorthosite (ca. 1070 Ma); 5-Lac St. Jean complex (1148 ± 4 Ma); 6-Sept Isles (1646 ± 2 Ma); 7-8-Harvre St. Pierre complex (1126 ± 7 Ma) including the Pentecote (1365 ± 7 Ma) anorthosite; 9-Shabagamo intrusives; 10-Mealy Mts. anorthosite (1646 ± 2 Ma); 11-12-Harp Lake anorthosite (ca. 1450 Ma); 13-Flowers River complex (ca. 1260 Ma); 14-Nain complex (1295 Ma) including Kiglapait intrusive (1305 ± 5 Ma). From McLelland (1989).

As demonstrated by recent U-Pb zircon* and Sm-Nd geochronology summarized (tables 1, 2) by Daly and McLelland (1991), McLelland and Chiarenzelli (1991) and Marcantonio et al. (1990), the Adirondack-CMB sector of the Grenville Province contains large volumes of metaigneous rocks that represent recent (i.e., ca. 1400-1200 Ma) additions of juvenile continental crust. These results (fig. 4) indicate that the Adirondack-CMB region experienced widespread calcalkaline magmatism from ca. 1300-1230 Ma. Associated high grade (sillimanite-K-feldspar-garnet) metamorphism has been fixed at 1226 ± 10 Ma by Aleinikoff (pers. comm.) who dated dust that had been air abraded from metamorphic rims on 1300 Ma zircons. Identical rocks, with identical ages, have been described from the Green Mts. of Vermont by Ratcliffe and Aleinikoff (1990), in northern Ireland by Menuge and Daly (1991), and in the Texas-Mexico belt of Grenville rocks (Patchett and Ruiz 1990). It appears, therefore, that a major collisional-magmatic belt was operative along the present southern flank of the Grenville Province during the interval 1300-1220 Ma and may have been related to the assembly of a supercontinent at this time. More locally, this magmatism and its associated metamorphism, represent the Elzevir Orogeny of the Grenville Orogenic Cycle, as defined by Moore and Thompson (1980). Within the Adirondacks, Elzevirian rocks are represented by 1300-1220 Ma tonalites and alaskites whose distribution is shown in figure 5. The apparent absence of this suite from the central Highlands is believed to be the combined result of later magmatic intrusion and recent doming along a NNE axis.

*Photomicrographs of typical zircons are given in fig. 29.

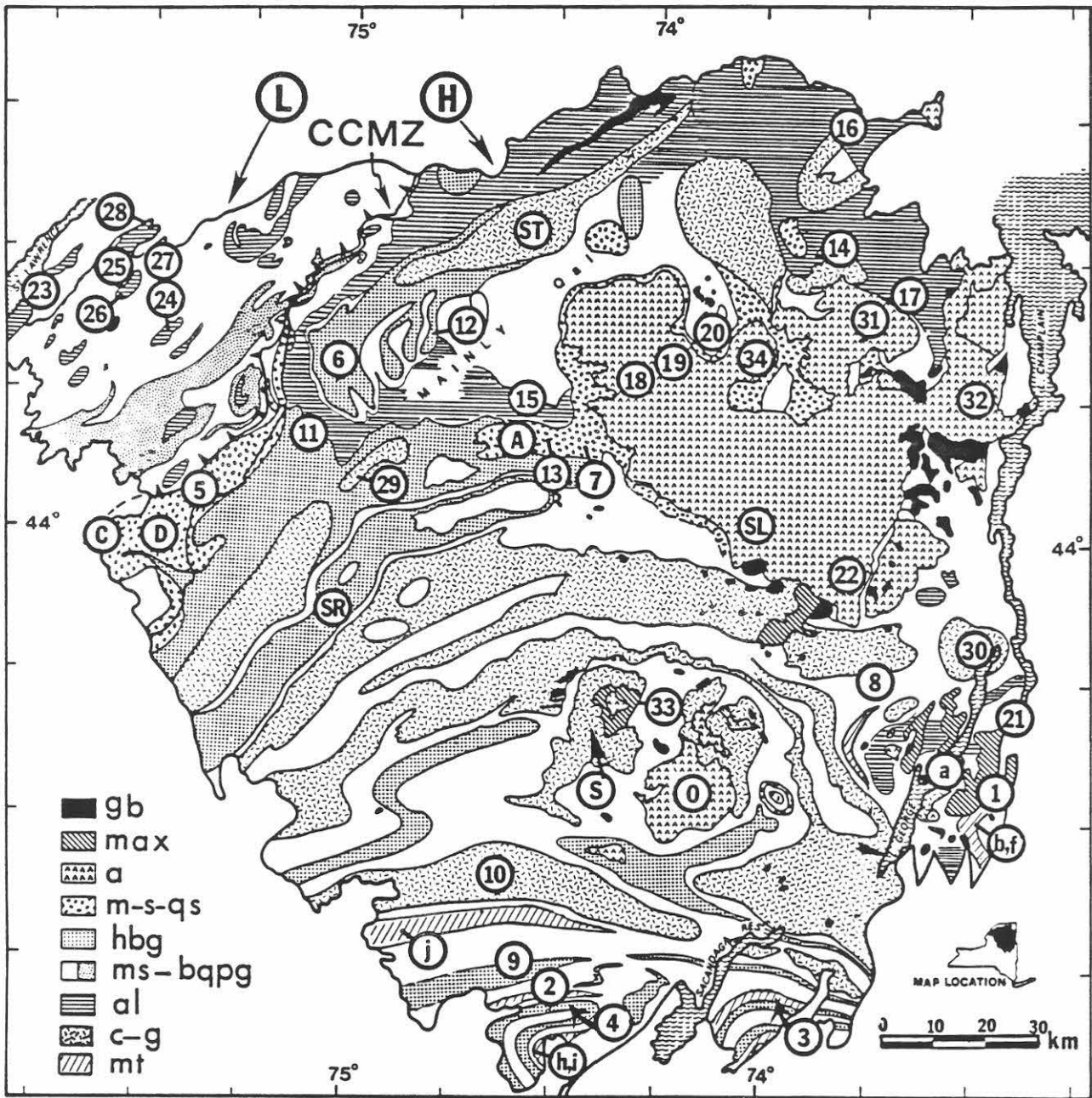

Fig. 2. Generalized geologic map of the Adirondack Highlands (H) and Lowlands (L). The Carthage-Colton Mylonite Zone (CCMZ) is shown with sawteeth indicating directions of dip. Numbers refer to samples listed in Tables 1 and 2. Map symbols: lmg=Lyon Mt. Gneiss, hbg=hornblende-biotite granitic gneiss, gb=olivine metagabbro, max=mangerite with andesine xenocrysts, a=metanorthosite, m-s-qs=mangeritic-syenitic-quartz-syenitic gneiss, ms=metasediments, bqpg=biotite-quartz-plagioclase gneiss, hsg=Hyde School Gneiss, mt=metatonalitic gneiss. Locality symbols: A=Arab Mt. anticline, C=Carthage anorthosite, D=Diana complex, O=Oregon dome, S=Snowy Mt. dome, ST=Stark complex, SR=Stillwater Reservoir, T=Tahawus, To=Tomantown pluton. From McLelland and Chiarenzelli (1990) and Daly and McLelland (1991).

Table I
U-Pb zircon ages for meta-igneous rocks
of the Adirondack Mountains

No.	Age (Ma)	Location	Sample No.
HIGHLANDS			
Tonalitic gneiss and related charnockite			
1	1329 ± 37	South Bay	AM-87-12
2	1301 ^a	Canada Lake	AM-86-12
3	1336 ^a	Lake Desolation	LDT
4	1233 ^a	Canada Lake	AM-87-13
Mangeritic and charnockitic gneiss			
5	1155 ± 4	Diana Complex ^b	
6	1147 ± 10	Stark complex	AM-86-15
7	1134 ± 4	Tupper Lake	AC-85-6
8	1125 ± 10	Schroon Lake	9-23-85-7
Older hornblende granitic gneiss			
9	1156 ± 8	Rooster Hill	AM-86-17
10	1150 ± 5	Piseco dome	AM-86-9
11	1146 ± 5	Oswegatchie	AC-85-2
Younger hornblende granitic gneiss			
12	1100 ± 12	Carry Falls	AM-86-3
13	1098 ± 4	Tupper Lake	AM-86-6
14	1093 ± 11	Hawkeye	AM-86-13
Alaskitic gneiss			
15	1075 ± 17	Tupper Lake	AM-86-4
16	1073 ± 6	Dannemora	AM-86-10
17	1057 ± 10	Ausable Forks	AM-86-14
Anorthosite and metagabbro			
18	1054 ± 20	Saranac Lake	AC-85-8 ^c
19	1050 ± 20	Saranac Lake	AC-86-7 ^d
20	996 ± 6	Saranac Lake	AC-85-9
Xenolith-bearing olivine metagabbro			
21	1144 ± 7	Dresden Station	AM-87-11
22	1057	North Hudson	CGAB ^e
LOWLANDS			
Leucogranitic gneiss			
23	1415 ± 6	Wellesley Island	AM-86-16
Alaskitic gneiss			
24	1284 ± 7	Gouverneur dome	AC-85-4
25	1236 ± 6	Fish Creek	AM-87-4
26	1230 ± 33	Hyde School	AC-85-5
Granitic and syenitic gneiss			
27	1150 ± 4	Edwardsville	AM-87-5
28	1155 ± 15	North Hammond	AM-87-3 ^f
HIGHLAND SAMPLES OF SILVER (1969)^g			
29	1113 ± 10	Fayalite granite, Wanakena	
30	1113 ± 16	Charnockite, Ticonderoga	
31	1084 ± 15	Undeformed syenite dyke, Jay	
32	1074 ± 10	Anorthosite pegmatite, Elizabethtown	
33	1064 ± 10	Metanorite, Snowy Mountain dome	
34	1054 ± 20	Sheared anorthosite pegmatite, Jay	
35	1009 ± 10	Magnetite-ilmenite ore, Tahawus ^h	

Note: Errors at two sigma.

^a Minimum Pb-Pb age.

^b Data from Grant *et al.* (1986).

^c Contains zircon cores, 1113 Ma, air abraded.

^d Baddeleyite age of 1086 ± 6 Ma from this sample.

^e Contains baddeleyite 1109 Ma.

^f Monazite age of 1137 ± 1 Ma.

^g Decay constants of Steiger and Jäger (1977).

^h Location same as Sanford Lake (SL) in Figure 1.

Table 2.: Sm-Nd data (sample numbers
in Table 1)

sample	L	Zircon age ¹	t _{DM} ²
ADIRONDACK HIGHLANDS			
Tonalites			
1 :AM87-12	t	1329 ± 36	1403
2 :AM86-12	t	1307 ± 2	1366
3 :LDT	t	>1366	1380
AMCG granitoids			
5 :DIA	s	1155 ± 4	1430
6 :AM86-15	r	1147 ± 10	1495
7 :AC85-6	m	1134 ± 4	1345
9 :AM86-17	e	1156 ± 8	1436
10 :AM86-9	g	1150 ± 5	1346
Younger granitoids			
13 :AM86-6	gd	1098 ± 4	1314
15 :AM86-4	a	1075 ± 17	1576
(repeat)			
:SK2A	tr	c.1060	1330
(repeat)			1373
Metasediment			
:JMCL-1	p	>c.1330	2075
Gabbro			
2I :Ali-1	g	1144 ± 7	1331
ADIRONDACK LOWLANDS			
Wellesley Island			
23 :AM86-16	l	1415 ± 6	1440
Fish Creek			
25 :AM87-4	a	1236 ± 6	1210
:5/90-5	t		
Hyde School			
26 :AC85-5	a	1230 ± 33	1351
:HS3	t	1230 ± 33	1397
:HS4	t	1230 ± 33	1350
Gouverneur			
24 :AC85-5	a	1284 ± 7	1525
ELZEVR TERRANE			
Northbrook			
9/88-9	t	1250	1245
Elzevir			
9/88-10	t	1275	1397

1: U-Pb zircon ages in Ma from McLelland and Chiarenzelli (1990a,b) and Grant *et al.* (1986); 2: Sm-Nd model ages in Ma (DePaolo 1981) from Daly and McLelland (1991) for the Highlands and McLelland, Daly and Perham (1991) for the Lowlands; L: lithologies, a=alaskite, e=enderbite, g=granite, gd=granodiorite, m=mangerite, p=pelite, s=syenite, t=tonalite, tr=trondhjemite, l=leucogranite, initial digits of sample numbers refer to localities in Fig. 2.

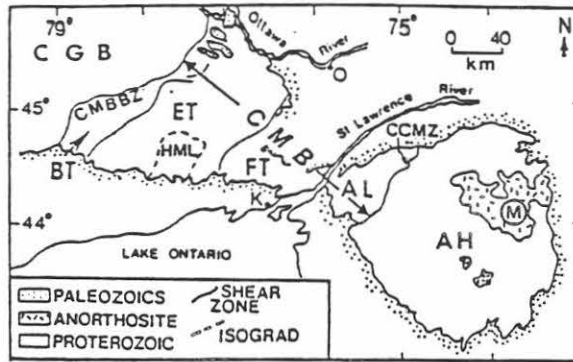

Fig. 3. Southwestern Grenville Province. CMB=Central Metasedimentary Belt, CGB=Central Gneiss Belt, BT=Bancroft Terrane, ET=Elzevir Terrane, FT=Frontenac Terrane, AL=Adirondack Lowlands, HL=Adirondack Highlands, HML=Hastings metamorphic low, K=Kingston, O=Ottawa, CCMZ=Carthage-Colton Mylonite Zone, M=Marcy massif.

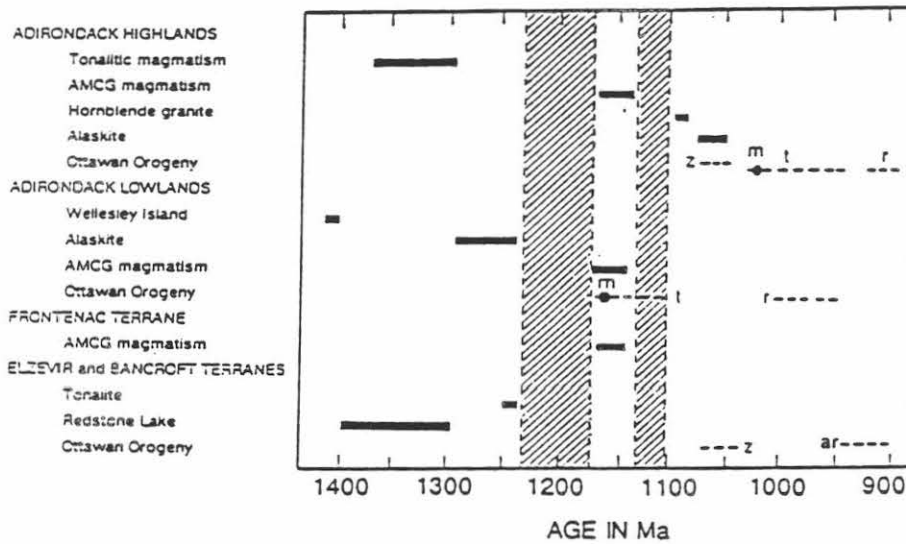

Fig. 4. Chronology of major geological events in the southwestern Grenville Province. z=zircon, t=titanite, m=monazite, r=rutile, ar=Ar/Ar. Diagonal ruling=quiescence. From McLelland and Chiarenzelli (1991).

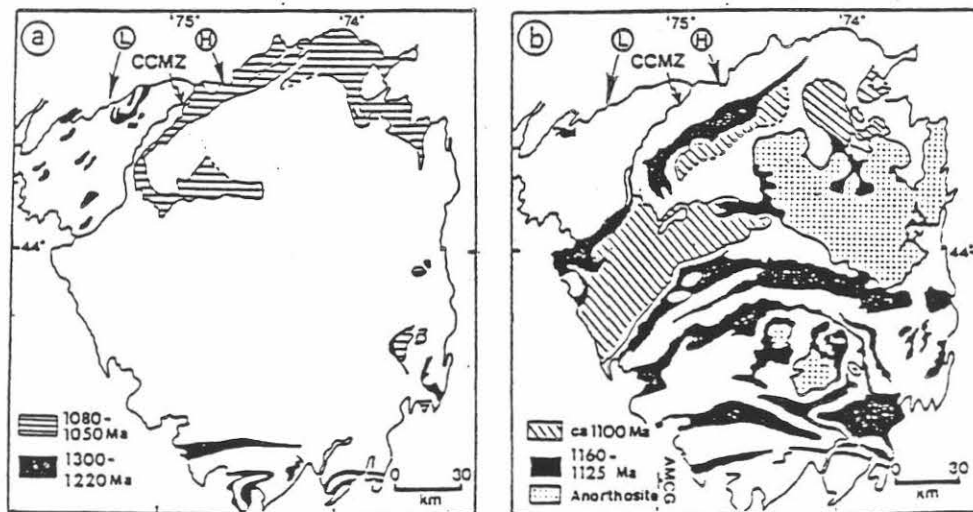

Fig. 5. Chronological designation of Adirondack units. L=Adirondack Lowlands, H=Adirondack Highlands, CCMZ=Carthage-Colton Mylonite Zone. From Chiarenzelli and McLelland (1991).

Within the Frontenac-Adirondack region, the Elzevirian Orogeny was followed by 40–50 Ma of quiescence terminated at 1170–1130 Ma by voluminous anorogenic (fig. 4) magmatism referred to as the anorthosite-mangerite-charnockite-granite (AMCG) suite. The older ages are characteristic of AMCG magmatism in the Frontenac Terrane (including the Lowlands) while the Highlands commonly exhibit ages of 1150–1130 Ma (fig. 5). The large Marcy anorthosite massif (fig. 2) and its associated granitoid envelope have been shown to have an emplacement age of ca. 1135 Ma (McLelland and Chiarenzelli 1990). These ages are similar to those determined (Emslie and Hunt 1990) for the Morin, Lac St. Jean, and several other large massifs farther northeast in the Grenville Province (fig. 1). Rocks of similar age and chemistry (i.e., Storm King Granite) have been described within the Hudson Highlands (Grauch and Aleinikoff 1985). The extremely large dimensions of the AMCG magmatic terrane emphasize its global-scale nature corresponding, perhaps, to supercontinent rifting with the rifting axis located farther to the east. Valley (1985), McLelland and Husain (1986), and McLelland et al. (1991a,b) have provided evidence that contact, and perhaps also regional, metamorphism accompanied emplacement of hot (~1000°C, Bohlen and Essene 1978), hypersolvus AMCG magmas. Wollastonite and monticellite occurrences related to thermal pulses from AMCG intrusions occur in proximity to AMCG intrusions (Valley and Essene 1980). In the Lowlands, and the Canadian sector of the Frontenac Terrane, monazite (table 1., no. 28), sphene (Rawnsley et al. 1987), and garnet ages (Mezger 1990) all indicate high temperatures (~600–800°C) at ca. 1150 Ma. Rutile ages and Rb/Sr whole rock isochron ages document temperatures not exceeding ~500 °C at ca. 1050–1000 Ma.

Following approximately 30 Ma of quiescence (Fig. 4), the Adirondacks, along with the entire Grenville Province, began to experience the onset of the Ottawa Orogeny of the Grenville Orogenic cycle (Moore and Thompson 1980). Initially the Ottawa Orogeny appears represented by 1090–1100 Ma hornblende granites in the northwest Highlands. These rather sparse granites were followed by deformation, high grade metamorphism, and the emplacement of trondhjemitic to alaskitic magnetite-rich rocks (Lyon Mt. Gneiss of Whitney and Olmstead 1988) in the northern and eastern Adirondacks. The zircon ages of these rocks fall into an interval of 1050–1080 Ma (table 1) which corresponds to the peak of granulite facies metamorphism when crust currently at the surface was at ~25 km. Accordingly, the alaskitic to trondhjemitic rocks are interpreted as synorogenic to late-orogenic intrusives. They were followed by the emplacement of small bodies of fayalite granite (ca. 1050 Ma) at Wanakena and Ausable Forks (fig. 2).

Sm-Nd analysis (Daly and McLelland 1991) demonstrates that the emplacement ages of the ca. 1300 Ma tonalitic rocks of the Highlands correspond closely to their neodymium model ages (table 1 and fig. 6a) indicating that these, most probably, represent juvenile crustal additions. As seen in figure 6a, ϵ_{Nd} evolution curves for AMCG and younger granite suites pass within error of the tonalitic rocks and suggest that the tonalites, together with their own precursors (amphibolites?), served as source rocks for succeeding magmatic pulses. Remarkably, none of these igneous suites gives evidence for any pre-1600 Ma crust in the Adirondack region and the entire terrane appears to have come into existence in the Middle to Late Proterozoic. Significantly, Sm-Nd analysis for the ca. 1230–1300 Ma tonalitic to alaskitic Hyde School Gneiss (table 1, fig. 6b) demonstrates that it has model neodymium ages and ϵ_{Nd} values similar to Highland tonalites. The results are interpreted to reflect the proximity of the Highlands and Lowlands at ca. 1300 Ma. Given this, the Carthage-Colton Mylonite Zone is interpreted as a west-dipping extensional normal fault that formed during the Ottawa Orogeny in response to crustal thickening by thrust stacking (Burchfiel and Royden 1985). East dipping extensional faults of this sort and age have been described by van der Pluijm and Carlson (1989) in the Central Metasedimentary Belt. Extensional motion along the Carthage-Colton Mylonite Zone would help to explain the juxtaposition of amphibolite and granulite facies assemblages across the zone. A downward displacement of 3–4 km on the Lowland block would satisfactorily account for the somewhat lower metamorphic grade of the Lowlands terrane.

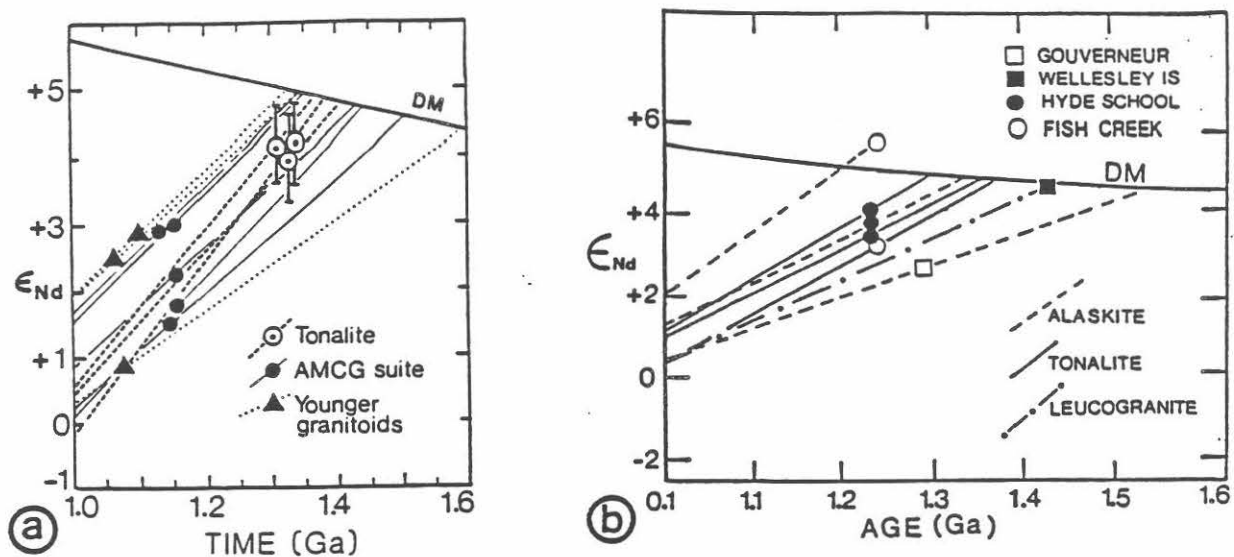

Fig. 6 ϵ_{Nd} evolution diagrams for (a) Adirondack highlands (Daly and McLelland 1991), (b) Adirondack lowlands (Hyde School Gneiss). U-Pb zircon ages are indicated by circles, triangles and squares (from table 1). DM=depleted mantle evolution curve (DePaolo 1981).

PETROLOGIC CHARACTERISTICS OF THE PRINCIPAL ROCK TYPES IN THE ADIRONDACKS

The following discussion is divided into igneous and metasedimentary sections.

Igneous Rocks

A) Tonalites and related granitoids. Typical whole rock chemistries for these rocks are given in table 3. Figure 7 shows the normative anorthite (An)-albite (Ab)-orthoclase (Or) data for these rocks and compares them to similar rocks in the Lowlands. AFM plots are given in fig. 8 and calc-alkali index versus silica plots in figure 9; both figures illustrate the strongly calcalkaline nature of the Highland tonalite to granitoid suite. A zircon typical of those in the tonalitic suite is shown in fig. 29a.

Tonalitic rocks, outcrop in several E-W belts within the southern Adirondacks. In the field they can be distinguished from, otherwise similar, charnockitic rocks by the white alteration of their weathered surfaces and the bluish grey on fresh surfaces. A distinctive characteristic is the almost ubiquitous presence of discontinuous mafic sheets. These have been interpreted as disrupted mafic dikes coeval with emplacement of the tonalites.

Associated with the tonalitic rocks are granodioritic to granitic rocks containing variable concentrations of orthopyroxene. In the southern Adirondacks, these are best represented by the Canada Lake Charnockite and by the large Tomantown pluton (fig. 2) whose minimum emplacement age is 1184 Ma (table 1). Within the Adirondack Lowlands pink, hypersolvus alaskitic gneiss, grey tonalite-trondhjemite, and a lesser volume of granitic to granodioritic gneiss are exposed in 14 domical culminations (figs. 2,5) and are grouped together as Hyde School Gneiss (Carl et al. 1990; McLelland et al. 1992). Sporadic orthopyroxene has been identified in all 14 domes of Hyde School Gneiss. Buddington (1939) interpreted these rocks as intrusive but Carl et al. (1990) have proposed a metavolcanic origin instead. McLelland et al. (1992) present a variety of evidence documenting an intrusive origin for Hyde School Gneiss. Conformable layers of amphibolite are interpreted as synorogenic mafic dikes or spalled-off wall rock (McLelland et al. 1992). McLelland et al. (1992) have interpreted the early calcalkaline rocks of the Highlands as correlative with the Hyde School Gneiss of the Adirondack Lowlands (fig. 2). This interpretation is consistent with the Sm-Nd results (table 2) discussed previously and shown in figure 6, however, the correlation is permissive of coeval evolution in a volcanic arc such as the Indonesian arc, and does not necessarily imply connection via continental crust (for which there is little, if any, evidence).

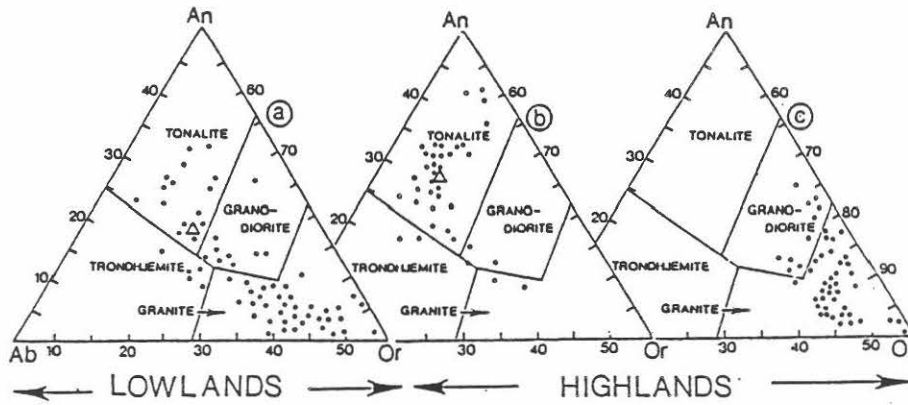

Fig. 7 Plots of normative albite (Ab)-anorthite(An)-orthoclase (Or) for (a) Hyde School Gneiss, (b) Highlands tonalites, and (c) Tomantown pluton. Open triangles give average values for tonalitic samples. Definition of fields due to Barker (1979).

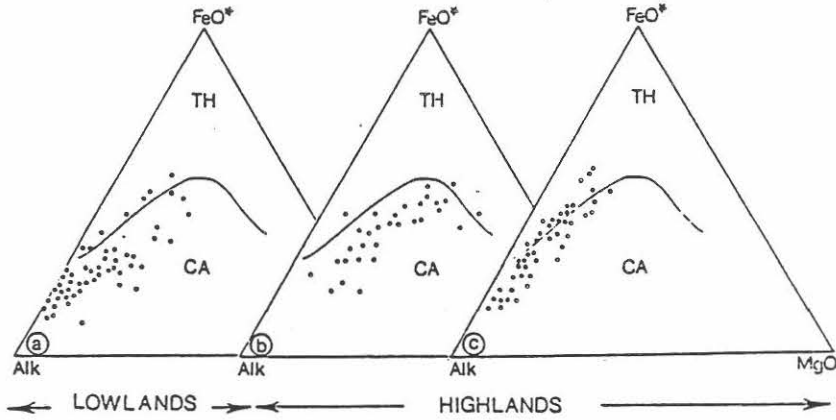

Fig. 8 AFM plots for (a) Hyde School Gneiss, (b) Highland tonalites, and (c) Tomantown pluton.

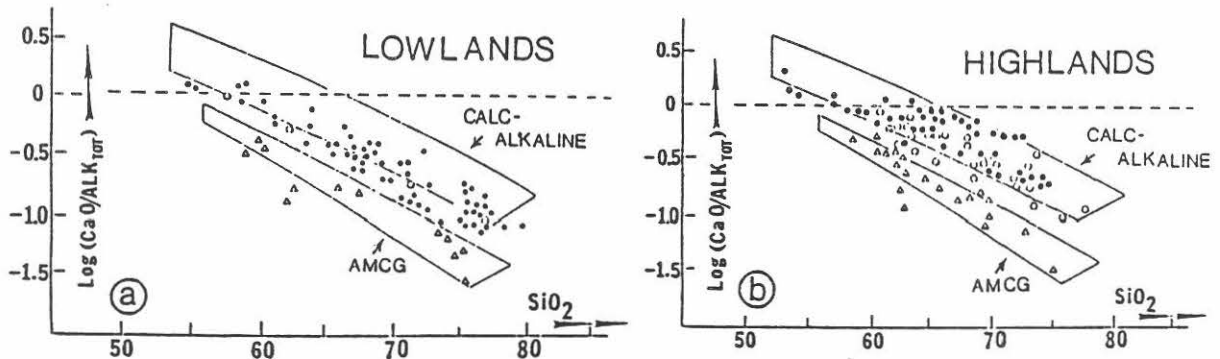

Fig. 9 Calcalkali ratio vs. wt % SiO_2 for (a) the Adirondack Lowlands and (b) the Adirondack Highlands. In (a) open circles are average values for Hyde School Gneiss, closed circles for typical Hyde School Gneiss, and open triangles for AMCG type rocks. In (b) open circles are for Tomantown pluton, closed circles for older calcalkaline rocks, and open triangles for AMCG rocks. Fields from Brown (1982).

B) AMCG Suite. Within the Adirondack Highlands AMCG rocks are widely developed and abundantly represented in the Marcy massif as well as the Oregon and Snowy Mt. Domes. The chemistry of granitoid (mangeritic to charnockitic) varieties of these rocks is given in table 3, both for the older as well as the younger anorogenic plutonic rocks. As shown in figure 9, the AMCG rocks have calcalkali-silica trends that are distinctly different than those shown by the tonalitic suites. McLelland (1991) and McLelland and Whitney (1991) have shown that the AMCG rocks exhibit within-plate anorogenic geochemical characteristics and also constitute bimodal magmatic complexes in which anorthositic to gabbroic cores are coeval with, but not related via fractional crystallization to the mangeritic-charnockitic envelopes of the AMCG massifs (i.e., Marcy massif, fig. 2). Bimodality is best demonstrated by noting the divergent differentiation trends of the granitoid members on the one hand and the anorthositic-gabbroic rocks on the other (Buddington 1972). This divergence is nicely exhibited by Harker variation diagrams (fig. 10) for AMCG rocks of the Marcy massif (McLelland 1989). The extreme low-SiO₂, high-iron end members of the anorthosite-gabbro family will be seen at several stops and are believed to represent late magmas developed under conditions of low oxygen fugacities (i.e., dry, Fenner-type trends). Associated with these are large magnetite-ilmenite deposits which will be visited at Sanford Lake. Detailed discussion of the anorthositic rocks will be given in a later section. Zircons typical of AMCG rocks are shown in figs. 29b,c.

Metamorphosed orthopyroxene-bearing mangerite and quartz syenite are commonly present at the margins of the large anorthosite bodies (figs. 2,5). These rocks, which locally crosscut the anorthosite, form a partial envelope around the Marcy Massif and completely surround the Snowy Mountain body. Blue-gray andesine xenocrysts, eventually derived from the anorthosite, are common in these rocks close to anorthosite contacts and are occasionally found up to 10 km from the nearest exposed anorthosite. Rapakivi textures are locally present within quartz syenitic gneisses of the Stark anticline and Diana Complex (Buddington 1939).

The mangerites have been variously interpreted as post-anorthosite intrusives (Buddington 1939); differentiates from a common granodioritic magma that also produced anorthosite (deWaard 1969); and as contact anatectic melts (Isachsen 1969). Both field evidence (Buddington 1939), trace element patterns (Simmons and Hanson 1978; Ashwal and Siefert 1980), and oxygen isotopes (Eiler and Valley 1990) appear to rule out models involving consanguinity with the anorthosites. The presence of mafic mangerite next to the anorthosite, possibly due to mixing of quartz mangeritic magma and mafic differentiates of the anorthosite suite, as well as local permeation of the anorthosite by mangerite and the presence of andesine xenocrysts in the mangerite, taken together suggest that the mangerite and anorthosite are coeval.

Within the Adirondack Lowlands, Carl and Sinha (1992) have determined a U-Pb zircon age of 1149±6 Ma for the widespread Hermon Granite. In contrast to the Highlands, the Lowlands AMCG suite is lacking in anorthosite and poor in mangerite and charnockite. This is consistent with the proposal that the Lowlands represent a downfaulted block of higher-level crust.

C) Olivine Metagabbros. Numerous bodies of olivine metagabbro and metatroctolite are scattered throughout the eastern and southern Adirondacks; these rocks are scarce to absent in the western highlands. The greatest concentration of metagabbros as well as the largest bodies are found along the eastern and southern margins of the Marcy anorthosite massif (fig. 2). Several of the larger bodies show a pronounced igneous layering. In a few locations, these rocks are seen to crosscut the anorthosites, but they may be only slightly younger. It is possible that these rocks may be intrusions into upper- or mid-crustal regions of olivine tholeiite magmas associated with anorthosite genesis in the upper mantle or lower crust (Emslie 1978). However, the metagabbros are relatively iron-rich (table 10) compared to undifferentiated tholeiites and thus have evidently undergone significant fractionation prior to emplacement. They differ from mafic members of the anorthosite suite in that the latter are usually quartz-normative, while the olivine metagabbros are strongly silica-undersaturated. McLelland and Chiarenzelli (1990) and Chiarenzelli and McLelland (1989) report a zircon age of 1144±7 Ma and a baddeleyite minimum age of >1113 Ma for two olivine metagabbros thus making them coeval with the anorthosite and strengthening the relationship between these rocks.

D) Younger Hornblende Granitic Rocks. The distribution of these rocks is shown in figure 5a and their chemistry is given in table 3. Their ages is given in table 1. An example of these rocks will be visited at Stop 12. In the field these rocks consist of medium grained, pink, streaky granitic rocks containing hornblende and minor biotite. They are difficult to distinguish from the granitic facies of the AMCG suite. As pointed out by Chiarenzelli and McLelland (1991), their restriction to the northwestern Highlands is intriguing but not yet understood. One sample of this unit (NOFo-1, table 3) contains two distinct zircon fractions, one of which consists of clear, elongate, prismatic zircons (1123-1154 Ma) and the other, more abundant fraction, consists of zoned, prismatic, dipyramidal zircons (1095±5 Ma). Chiarenzelli and McLelland (1991) interpret the older zircons as xenocrysts from AMCG source rocks and the 1095±5 Ma age as the time of emplacement of the granite. It appears, therefore, that the younger granitic rocks represent remelted volumes of AMCG rocks, examples of which they occur in. This interpretation is consistent with Sm-Nd results (fig. 6). Zircons typical of these rocks are shown in fig. 29d.

E) Alaskitic and Leucogranitic Rocks. The distribution of these distinctive rocks is shown in fig. 5a. Their geochronology is summarized in tables 1 and 2 and the chemistry in table 3. An example of these rocks will be visited at Stop 10. They consist principally of pink quartz-mesoperthite gneiss commonly with magnetite as the only dark phase. A less voluminous, but important, trondhjemitic facies is also common and is commonly associated with low-Ti magnetite deposits in the unit. Granitic facies also occur within this group which, together, constitutes the Lyon Mt. Gneiss (Whitney and Olmsted 1988). U-Pb zircon ages of 1080-1050 Ma for these rocks are interpreted as dating emplacement, and, since this time interval corresponds to granulite facies metamorphism at ~25 km, the Lyon Mt. Gneiss is interpreted as intrusive (Chiarenzelli and McLelland 1991). This is in contrast to Whitney and Olmsted (1988) who have interpreted the Lyon Mt. Gneiss as a metamorphosed series of altered acidic volcanics. This issue is discussed in detail in the text for Stop 10. Zircons typical of these rocks are shown in figs. 29c-h.

F) Pegmatite and Granitic Dikes. Pegmatitic and granitic dikes, both deformed and undeformed, are scattered throughout the region but are most common in the southeast. An Rb/Sr muscovite age of 963±40 Ma (b. Giletti, written communication to YWI) obtained from a late undeformed pegmatite from the southeasternmost Adirondacks, suggests that these are young pegmatites associated with late Middle Proterozoic uplift cooling of the Adirondack metamorphic terrane. However, Putman and Sullivan (1979) have shown that the composition of some of these dikes is consistent with an origin at high (7 kbar) pressure, after cessation of deformation but before major uplift had occurred.

G) Metasedimentary Rocks. Within the southern Adirondacks the metasedimentary sequence is dominated by quartzites and metapelites with marbles being virtually absent. The quartzites are exceptionally thick and pure and comprise an ~1000 m-thick unit referred to as the Irving Pond Quartzite. Of even greater extent, as well as thickness, is the Peck Lake Formation which consists of garnet-biotite-quartz-oligoclase ± sillimanite gneiss (referred to as kinzigite) together with sheets, pods, and stringers of white, minimum melt granite that commonly contains garnets. McLelland and Husain (1986) interpreted the kinzigites and their leucosomes as restite-anatectite pairs and attributed partial melting to heating accompanying AMCG magmatism. It is now believed that an additional period of anatexis probably preceded the 1130-1150 Ma AMCG magmatism during the 1300-1220 Elzevirian Orogeny.

The occurrence of anatexis within the kinzigites is corroborated by the presence of sparse hercynitic spinel within either garnets or sillimanite-rich wisps in leucosomes. McLelland et al. (1991a; 1992) have shown that extraction of anatectic material from the least altered kinzigites can satisfactorily account for the composition of more aluminous, lower-silica kinzigites. The ultimate evolution of this process would be to produce assemblages of aluminous sillimanite-garnet-biotite gneiss together with granitic material of the sort that characterizes the Sacandaga Formation of the southern Adirondacks. At their contact with large AMCG plutons (e.g., ca. 1155 Ma rocks coring the Piseco anticline, fig. 2) these rocks develop assemblages that commonly contain sillimanite, garnet, spinel, and corundum. This association suggests that anatexis occurred during ca. 1150-1130 Ma contact metamorphism associated with the AMCG suite.

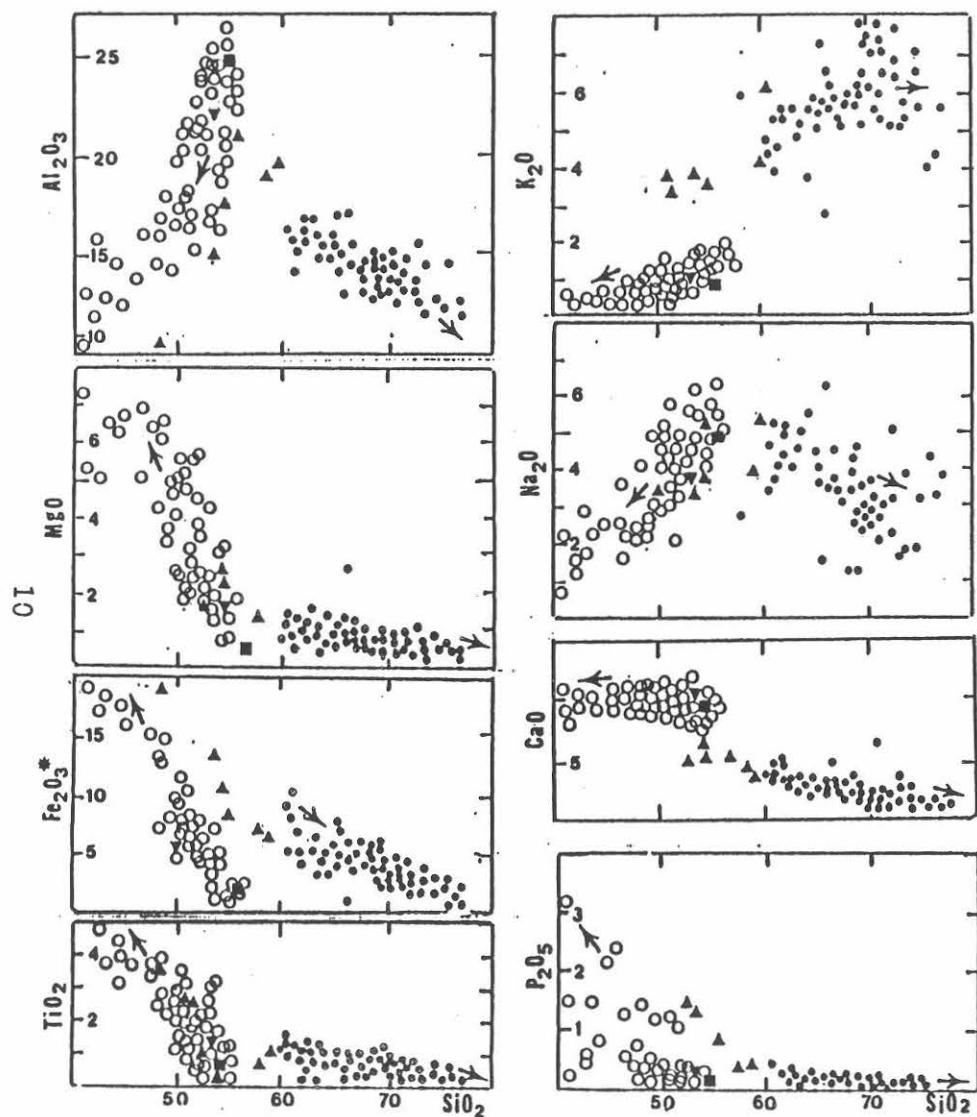

Fig. 10 Harker variation diagrams for AMCG-rocks of the Marcy massif. Open circles=anorthositic suite, filled circles=granitoid suite, upright triangles=mixed rocks, inverted triangles=Whiteface facies, square=Marcy facies. Arrows indicate differentiation trends.

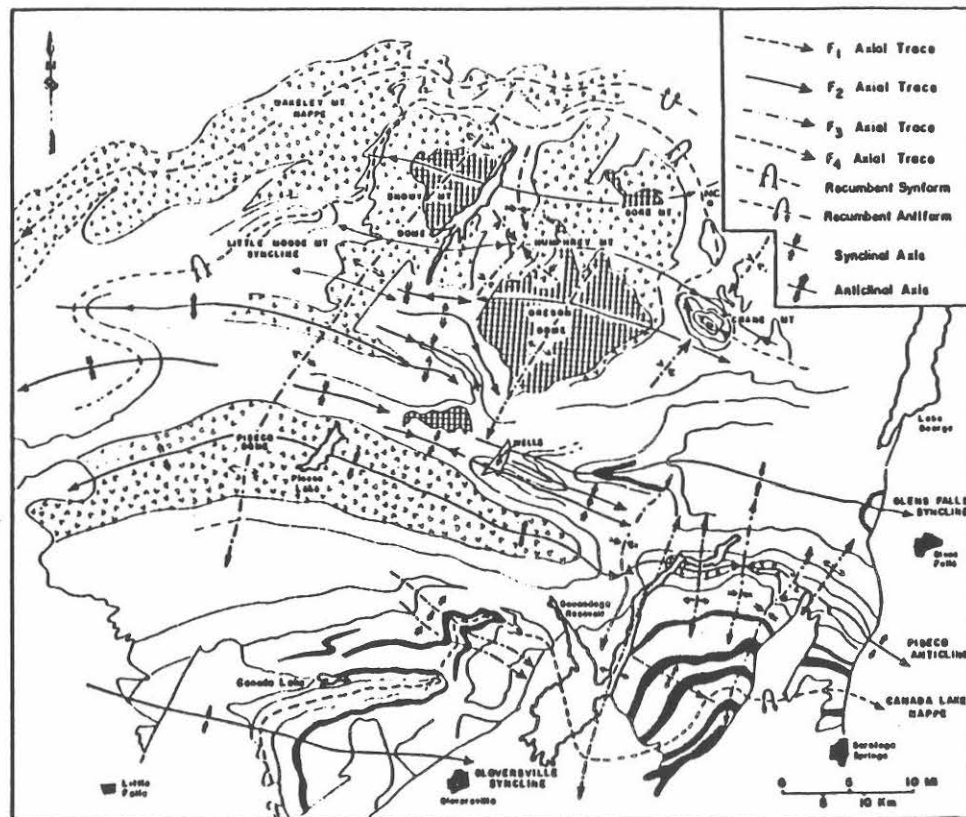

Fig. 11 Fold axes within the southern and central Adirondacks. Designation of folds as synclines and anticlines is provisional, since facing directions are not yet known.

Based on the bulk chemistry of kinzigites in the southern Adirondacks, McLelland and Husain (1986) interpreted their protoliths as Proterozoic greywackes and shales. More recently, McLelland et al. (1991b) have provided evidence to support the conclusion that the Peck Lake Fm. kinzigites of the southern Adirondacks can be correlated with the markedly similar Major Paragneiss of the Adirondack Lowlands (bqpg on fig. 2). McLelland and Isachsen (1986) have also demonstrated that the Peck Lake Fm., and associated rocks, continues into the eastern Adirondacks in the vicinity of Lake George.

In contrast to the southern and eastern Adirondacks, the central Adirondacks contain only sparse kinzigite, and metasediments are principally represented by synclinal keels of marble and calcsilicate. It is possible that the change from carbonate to pelitic metasediments corresponds to an original shelf-to-deep water transition, now largely removed by later intrusion, doming, and erosion. Within the northern Adirondack Highlands, marbles and calcsilicates are commonly the only metasedimentary rocks reported, although sillimanite-garnet gneisses do occur near Sabbattis where a possible megaxenolith occurs (fig. 2). In proximity to AMCG intrusion the calcsilicates develop pyroxene, garnet, and wollastonite skarns. These will be visited at Stop 6 (Cascade Slide) together with akermanite-monticellite occurrences.

A single specimen of metapelite (no. 21, table 2) has yielded a T_{DM} of 2075 Ma. This model age approximates the time at which source rocks for the metasediment separated from the mantle. Although the age may be the result of mixing rocks >2075 Ma with younger components, the older material clearly predates any possible Adirondack sources. Sm-Nd analysis of Adirondack metasediments is continuing and some results will be presented at this conference.

STRUCTURAL GEOLOGY

Southern Adirondacks

The regional structural framework of the Adirondacks is best known from the southern Adirondacks, and a brief review of this structure is presented as representative of much of the rest of the Adirondacks.

The southern Adirondacks is an area of intense ductile strain, essentially all of which must postdate the ca. 1150 Ma AMCG rocks which are involved in each of the major phases of deformation, i.e., the regional strain is associated with the Ottawa Orogeny.

As shown in figures 2 and 11, the southern Adirondacks are underlain by very large folds. Four major phases of folding can be identified and their intersections produce the characteristic fold interference outcrop patterns of the region (figs. 11, 12).

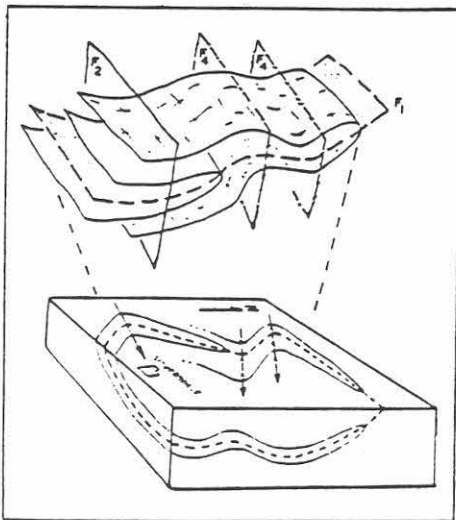

Fig. 12 Block diagram showing how interference between F_1 , F_2 , and F_4 fold sets produce the outcrop pattern of the F_1 Canada Lake isocline. The axial plane of the F_1 fold is stippled and its fold axis plunges 10-15° to the southeast. The city of Gloversville is shown.

The earliest recognizable map-scale folds (F_1) are exceptionally large isoclinal recumbent structures characterized by the Canada Lake, Little Moose Mt., and Wakely Mt. isoclines, whose axes trend E-W and plunge 10-15° about the horizontal. The Little Moose Mt. isocline is synformal (deWaard 1964) and the other two are antiformal, and suspected to be anticlinal, but the lack of stratigraphic facing directions precludes any certain age assignments although these are designated in figure 12 on a provisional basis. All of these structures fold an earlier tectonic foliation consisting of flattened mineral grains of unknown age and origin. An axial planar cleavage is well developed in the Canada Lake isocline, particularly in the metapelitic rocks.

F_2 -folds of exceptionally large dimensions trend E-W across the region and have upright axial planes (fig. 12). They are coaxial with the F_1 folds suggesting that the earlier fold axes have been rotated into parallelism with F_2 and that the current configurations of both fold sets may be the result of a common set of forces. An intense ribbon lineation defined by quartz and feldspar rods parallels the F_2 -axes along the Piseco anticline, Gloversville syncline, and Glens Falls syncline and documents the high temperatures, ductile deformation and mylonitization that accompanied the formation of these folds.

Large NNE trending upright folds (F_3) define the Snowy Mt. and Oregon domes (fig. 12). Where the F_3 folds intersect F_2 axes structural domes (i.e., Piseco dome) and intervening saddles result. A late NW-trending fold set results in a few F_4 folds between Canada Lake and Sacandaga Reservoir (fig. 12).

Kinematic indicators (mostly feldspar tails) in the area suggest that the dominant displacement involved motion in which the east side moved up and to the west (McLelland 1984). In most instances this implies thrusting motion, however, displacement in the opposite sense has also been documented. This suggests that relative displacement may have taken place in both senses during formation of the indicators. A movement picture consistent with this is still under investigation, although regional extension analogous to that in core complexes might resolve the situation.

METAMORPHISM

Figure 13 shows the well known pattern of paleoisotherms established by Bohlen and Essene (1977) and updated in Bohlen et al. (1985). Paleotemperatures have been established largely on the basis of two-feldspar geothermometry but (Fe, Ti)-oxide methods have also been used and, locally, temperature-restrictive mineral assemblages have been employed (Valley 1985). The bull's eye pattern of paleoisotherms, centering on the Marcy massif, is believed to be due to late doming centered on the massif. Paleopressures (fig. 14) show a similar bull's eye configuration with pressures of 7-8 kbar decreasing outward to 6-7 kbar away from the massif and reaching 5-6 kbar in the Lowlands (Bohlen et al. 1985).

Bohlen et al. (1985) interpret the paleotemperature pattern of figure 13 as representative of peak metamorphic temperatures in the Adirondacks, and paleopressures are interpreted similarly. Chiarenzelli and McLelland (1991) show that disturbance of U-Pb systematics in zircons corresponds to the configuration Bohlen et al.'s (1985) paleoisotherms (fig. 13), and this correlation strengthens the conclusion that the pattern is one of peak temperatures rather than a retrograde set frozen in from a terrane of uniform temperatures in the range ~750°-800°C. Recently, Mezger et al. (1991) have reported U-Pb garnet ages 1013-1026 Ma in the vicinity of the Marcy massif. They suggest that these may represent a late pulse of metamorphism in this portion of the Adirondacks. These garnet ages occur within the same area exhibiting disturbed zircon ages and both sets of results are consistent with slow, high temperature cooling, or a late metamorphic pulse.

The P,T conditions of the Adirondack Highlands are those of granulite facies metamorphism, and for the most part conditions correspond to the hornblende-clinopyroxene-almandine subfacies of the high-pressure portion of the granulite facies (fig. 15). These conditions must have been imposed during the Ottawa Orogeny since they have affected rocks as young as 1050 Ma. The identification of ca. 1050-1060 Ma metamorphic zircons by McLelland and Chiarenzelli (1990) fixes the time of peak metamorphic conditions and corresponds well with titanite and garnet U-Pb ages of ca. 1030-1000 Ma in the Highlands (Mezger 1990). Rb-Sr whole rock isochron ages of ca. 1100-

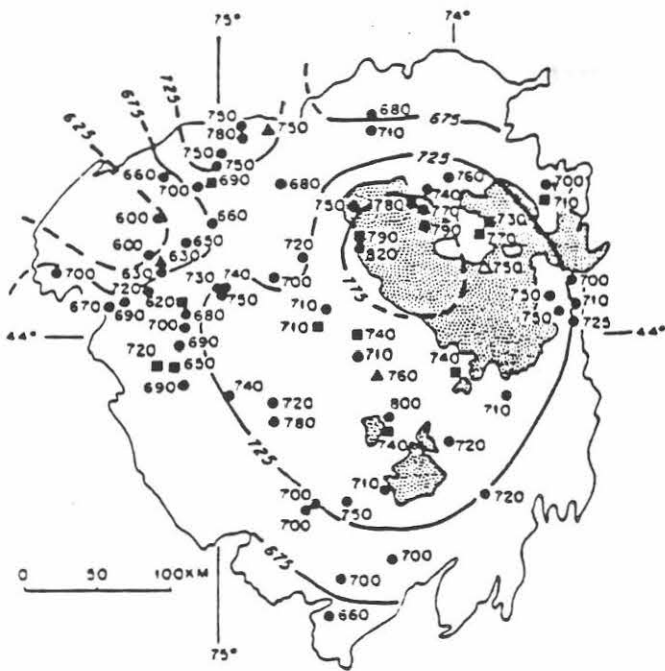
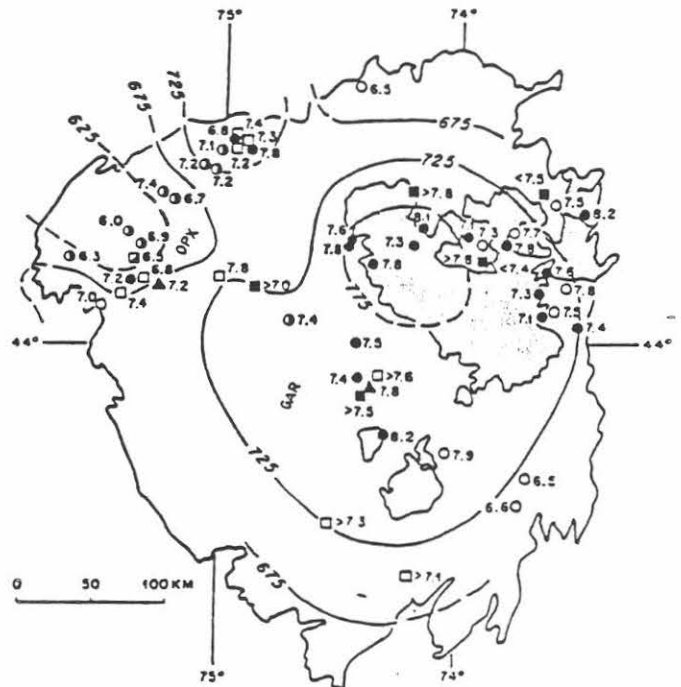

Figure 13 Metamorphic temperatures, in °C, after Bohlen and others (1985). Temperatures from coexisting feldspars (filled circles); magnetite-ilmenite (squares); calcite-dolomite (filled triangles); and akermanite (open triangle). Stippled area: anorthosite.



□ ILMENITE-SILLIMANITE-QUARTZ-GARNET-RUTILE
 ■ FERROSILITE-FAYALITE-QUARTZ
 ◻ SPHALERITE-PYRRHOTITE-PYRITE
 ○ FAYALITE-ANORTHITE-GARNET
 ● FERROSILITE-ANORTHITE-GARNET-QUARTZ
 ◐ ANORTHITE-GARNET-SILLIMANITE-QUARTZ
 ◑ KYANITE-SILLIMANITE
 △ AKERMANITE

Figure 14 Metamorphic pressures, after Bohlen and others (1985). Contours are temperatures from Figure 13

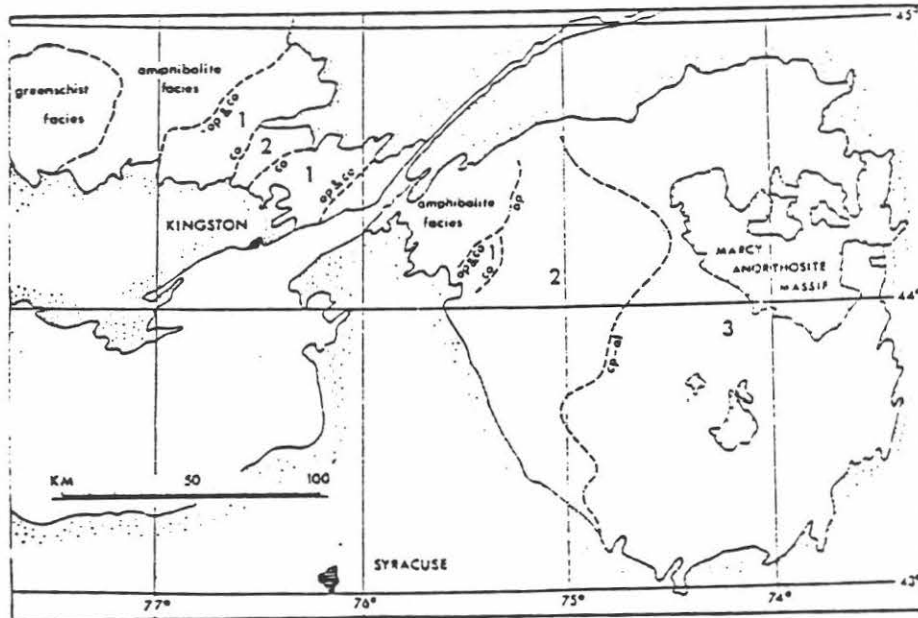

Figure 15 Facies distribution and isograds in the Precambrian terrane of the Adirondacks and Frontenac Axis, after deWaard (1967). The granulite facies is subdivided into zones numbered in order of progressive metamorphism: 1 - the biotite-cordierite-almandite subfacies, 2 - the hornblende-orthopyroxene-plagioclase subfacies, and 3 - the hornblende-clinopyroxene-almandite subfacies.

1000 Ma also reflect Ottawa temperatures and fluids. Despite the high-grade, regional character of the Ottawa Orogeny, the preservation of foliated garnet-sillimanite xenoliths in an 1147±4 Ma metagabbro (McLelland et al. 1987a), and the report of some 1150 Ma U-Pb garnet ages (Mezger 1990), reveals that earlier assemblages from the Elzevirian and AMCG metamorphic pulses managed to survive locally. The dehydrating effects of these high temperature events, as well as the anhydrous nature of the AMCG rocks themselves, are thought to be responsible for creating a water-poor terrane throughout the Adirondack Highlands prior to the Ottawa Orogeny.

THE MARCY ANORTHOSITE MASSIF AND RELATED ROCKS

The Marcy anorthosite massif is roughly elliptical in shape with a NW-trending major axis of close to 100 km and NE-trending minor axis of 60 km (fig. 2). Simmons (1964) conducted a gravity investigation of the massif and, after removing a long-wavelength regional anomaly, interpreted the residual Bouguer anomaly as due to a 3-5 km anorthositic sheet with two underlying cylindrical roots (figs. 16,17) pointed out by Morse (1982), and summarized by Thomas (1990), this model precludes underlying mafic cumulates (at least in the crust) and suggests that the massif crystallized from an anorthositic magma. Simmons' interpretation depends upon density contrasts based upon assumed densities for the anorthosite and country rocks. Simmons chose an unrealistically low CI of 4 for the anorthosites, and a more representative choice of 10-15 would result in other solutions, some of which permit the existence of high density rocks in the crust beneath the massif. Consistent with this possibility is the presence of a zone of strong seismic reflectors at ~20 km (Brown et al. 1983) and a wave-length filtered positive gravity anomaly of ~10 mGal over the Adirondack region (Morse 1982). Currently the issue of mafic cumulates in the deep crust remains unresolved, but the general slab-like configuration of Simmons' model (fig. 17) is consistent both with gravity and seismic data and is believed to be essentially correct. We suggest that mafic cumulates, due to early fractionation, may be located in the upper mantle and thus remain geophysically invisible.

A) Anorthositic Rocks of the Massif

The anorthositic rocks of the Marcy massif consist almost entirely of plagioclase-pyroxene assemblages ranging in composition from gabbro to anorthosite. Whole-rock analyses and modes are given in tables 4-7. The more gabbroic facies are most common near the massif margins where they outline the broadly domal configuration of the intrusion. Buddington (1939, p. 19) subdivided these rocks as follows:

<u>Rock Name</u>	<u>% mafic minerals (CI)</u>
Anorthosite	<10
Gabbroic Anorthosite	10-22.5
Anorthositic Gabbro	22.5-35
Gabbro or Norite	35-65
Mafic Gabbro or Norite	65-77.5

The plagioclase within these rocks varies in composition from AN₄₀-AN₅₅ with the average value near AN₄₅, with the anorthite content decreasing towards more gabbroic compositions (tables 5a, 5b). In general, both calcium-rich and calcium-poor pyroxenes are present (tables 4,5) but one-pyroxene anorthosites (i.e., noritic or gabbroic) are not uncommon. Calcium-rich pyroxenes tend to dominate, especially in more gabbroic facies (Buddington 1939, p. 33; Crosby 1968, p. 293), but reverse instances are known. Buddington (1939, p. 33) suggested that calcium-rich pyroxene increase with the extent of rock alteration as indicated by granular rims of augite around orthopyroxene and by the increase of the latter in many unaltered rocks. Davis (1971, p. 12) attributes the calcic-pyroxene rims on orthopyroxene to complete exsolution of pyroxene solid solutions. In general, and regardless of origin, it has long been recognized (e.g. Kemp 1910, p. 28) that calcium-rich pyroxene is usually slightly more abundant than calcium-poor pyroxene throughout the anorthositic suite of rocks of the Adirondacks (tables 4, 5).

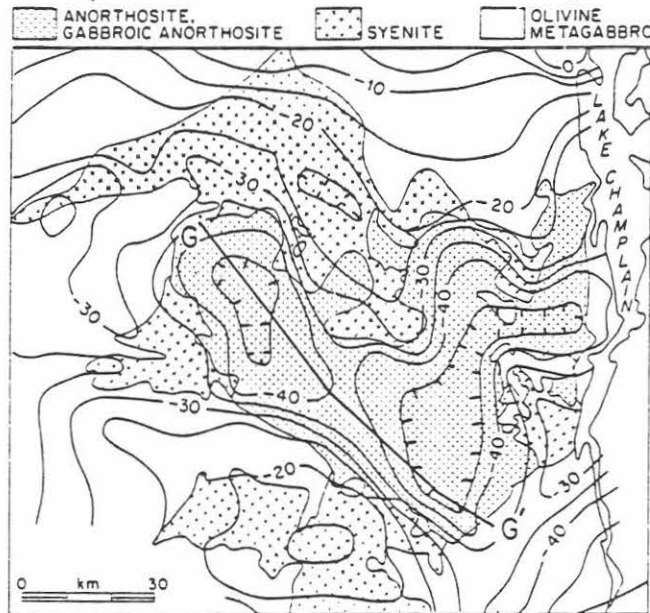

METASEDIMENTARY ROCKS & GRANITIC GNEISSES
Figure 16 Simplified geological map of the Marcy massif with Bouguer gravity anomaly contours (5 mGal interval) superimposed (after Simmons, 1964). Closed contours with tick marks indicate gravity lows.

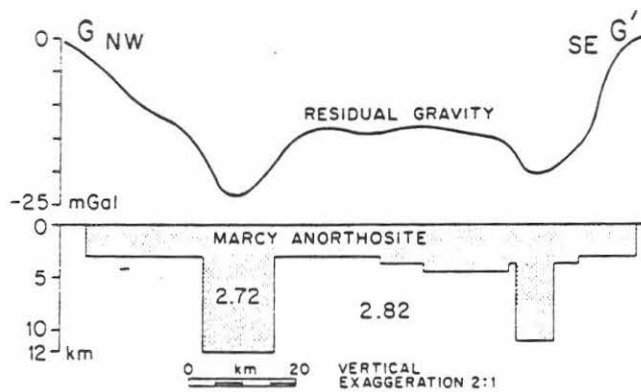

Figure 17 Residual gravity anomaly profile and model of Marcy anorthosite along line G-G' of Figure 9 (after Simmons, 1964); densities in g/cm^3 .

A terminology long-utilized in the description of Adirondack anorthosites was based upon subdivisions by Kemp (1898, p. 57-58) and Miller (1919, p. 17-20). The former applied the term "Whiteface facies" to chalky white, medium grained (2-5 mm), more mafic, and commonly foliated rocks commonly present along the margins of the massif (see table 5b). The Whiteface facies also contains sparse megacrysts of blue-gray andesine and is relatively rich in garnet and black hornblende. In contrast, Miller (1919), named the rock characteristic of the core of the massif the "Marcy facies" (table 5a) and described this as an andesine-rich, bluish-gray, coarse-grained (plagioclase: 2-5 cm in general and rock up to 22 cm) containing less than 10% dark minerals and with little, or no, foliation. Within this facies a light gray-green groundmass of granulated plagioclase is generally subordinate but may predominate over plagioclase megacrysts which, on the average, constitute 50-75% of the rock. Coronas of garnet on pyroxene and oxide are common and have been discussed by McLelland and Whitney (1977) and McLelland (1990). Tables 5a and 5b summarize Crosby's (1968) investigation of Whiteface and Marcy facies. Note that the Marcy type actually has a color index of 16 and that of the Whiteface type is 24, indicating that both anorthositic groups are somewhat more mafic than is generally assumed.

The terms Whiteface and Marcy facies were useful to early workers as "formational" categories but had become cumbersome even by the time of Buddington's investigations of the 1920's (see, for example, Buddington 1939, p. 21). As a result, he adopted the classification based on color index given above, and we do likewise here. The merit of this choice lies in the recognition that, although the borders tend to be more mafic (Davis 1968, Buddington, 1939, p. 47), both facies occur throughout the massif, and, more importantly, the massif consists of several varieties of plagioclase-pyroxene-oxide rocks intruded in several distinct pulses. Notwithstanding these observations the term Marcy facies remains useful for occurrences of blue grey, coarse grained anorthosite, and Whiteface Mt. most certainly consists of Whiteface type anorthosite, par excellence.

As recognized by Buddington (1939, p. 21), the Marcy massif is a composite intrusion. In addition to several regional subdivisions (Marcy-St. Regis, Jay-Whiteface, Westport) there is ubiquitous outcrop-scale evidence for the existence of multiple magmatic pulses. These are manifested by "block structure" (Balk 1931, p. 357-358) and by the more complete disruption and formation of xenoliths of one type of anorthosite in another. Examples of block structure will be seen at Woolen Mill, Jay, Lake Clear, and on Giant Mt. and other cross-cutting structures will be examined elsewhere. In general, more mafic varieties of rock invade and disrupt the felsic types, but repeated pulses tend to cause apparent reversals. In nearly all instances it appears that coarse (5-10 cm), blue-grey andesine-anorthosite of the Marcy type is the oldest rock type and commonly occurs as xenoliths and rafts in medium grained, augitic anorthositic gabbro. This is cut, in turn, by a finer grained anorthosite or gabbroic anorthosite. New injections of gabbroic rock may then disrupt the earlier facies. Relationships of this sort are shown in fig. 2 of the accompanying article by McLelland and Chiarenzelli (1990). The feldspathic facies are disrupted, in turn, by mafic rocks ranging from ferrogabbros to oxide-pyroxene ultramafics, both of which are discussed later in this section. Here we note that it is common for intruded blocks or xenoliths of one type of anorthosite to exhibit linear and planar fabrics that are truncated by other types of anorthosite. These fabrics evidently formed during the 1135-1125 Ma interval of AMCG emplacement and are interpreted as the result of local strains due to magmatic processes rather than a result of regional compression. This conclusion is itself consistent with the lack of evidence for regional compression during the emplacement of the AMCG suite.

Buddington (1939, p. 46-48) and Davis (1971, p. 26-27) interpret the more mafic gabbroic anorthosite (i.e., Whiteface) facies that is concentrated at the border of the Marcy massif as a chilled phase representative of the parental magma of the anorthosite suite. As noted by Buddington most of the border facies is granulated and interpreted as a deformed, and recrystallized, derivative of a once coarser primary rock. However, he cites examples of undeformed lenses of gabbroic anorthosite with grain size less than 1 cm and notes the widespread presence of 2-5 mm subophitic pyroxenes in occurrences of gabbroic anorthosite throughout the massif. These relationships strongly suggest that much of the finer grained gabbroic anorthosite is a primary intrusive rather than the result of granulation and grain size reduction of coarser anorthosite. This conclusion is supported by the observation that blue-gray andesine megacrysts in these rocks commonly preserve rectangular, euhedral outlines against sharp contacts with fine grained gabbroic anorthosite. If the fine grained facies were due to granulation, then the megacrysts should have had their original crystal outlines

rounded and reduced by strain. In these cases the An content of megacrystic and groundmass plagioclase differ by 5-11% (Buddington 1939, p. 47) in contrast to granulated plagioclase in anorthosite (i.e., Marcy type) which has the same composition as coarser grains. These observations provide compelling evidence for a magmatic, rather than a tectonic, origin for the finer grained gabbroic anorthosite and indicate that it intruded, disrupted, and incorporated coarser anorthosite and andesine megacrysts into itself. This interpretation is wholly consistent with outcrop evidence of cross-cutting relationships that are best interpreted as intrusive, and, in many instances, they provide evidence for the existence of magmas with plagioclase exceeding 85% of the mode.

It is not unlikely that magma approximating the composition of gabbroic anorthosite gave rise to local accumulations of andesine plagioclase together with more mafic liquids. Ashwal (1978) used observed whole rock and mineral compositions to calculate the liquid line of descent of gabbroic anorthosite starting materials and found that the results corresponded closely to observed rock compositions in the anorthosite suite. As important as these results are, they probably represent "late" events in a longer fractionation history such as envisaged by Emslie (1985) and Morse (1982), and, in this important sense, the gabbroic anorthosites are not ultimate parental magmas to the anorthosites. Moreover, the Marcy massif contains a large number of anorthositic types (table 5), and not all of these necessarily formed by the same processes. What we wish to stress here is that the observations cited in the preceding paragraph establish the existence of a gabbroic anorthosite magma with up to 90% plagioclase component. As yet, we cannot state the percentage of this magma that was liquid, but we can say, with certainty, that this magma was sufficiently fluid to intrude in sheet-like form and to penetrate, and disrupt, coarse anorthosite in an intimate fashion. Moreover, this phase of the massif is widespread and has commonly been misinterpreted as granulated Marcy-type anorthosite. Thus, a good deal of the massif consists of anorthositic magma that is non-cumulate in origin and is properly regarded as an intrusive rock of approximately anorthositic composition.

Anorthositic gabbro gradational to gabbro is common in the Marcy massif (tables 4, 5). The medium grained (1-2 cm) rocks consist of 50-70% plagioclase speckled with sub-ophitic augite together with subordinate bronzite or hypersthene. These rocks bear intrusive relationships to other types of anorthosite and play a prominent role in block structure. Good examples will be seen on Giant Mt. and at Woolen Mill. Although augite-rich varieties dominate, examples of noritic facies exist and are more common in iron enriched facies. Buddington (1962), citing field evidence, drew attention to the iron-enrichment, silica-depletion fractionation trend of the anorthositic series (fig. 10 of this volume) and its reflection of magmatic evolution in a dry, low f_{O_2} , plagioclase-dominated process. Fractionation of gabbroic anorthosite magma can result in the production of small quantities of Fe, Ti, and P-rich ferrogabbro, ferrodiortite, and oxide-clinopyroxene-pigeonite (fayalite) rocks containing little plagioclase and variable quantities of apatite (see Stops 7,8). These silica saturated, olivine-normative compositions closely resemble the sparse, but ubiquitous, mafic rocks associated with the Marcy massif. Ashwal (1978, 1982) divided these mafic rocks into conformable cumulates and cross-cutting dikes and sheets as well as dikes of mobilized cumulate material. While the cross-cutting dikes are the most likely varieties to represent late liquids, it is by no means obvious that the conformable layers are all cumulate in origin. It is possible that most, if not all, of these mafic rocks represent magmas, especially those that contain both plagioclase and pyroxene. Poor exposure and intense tectonism make it difficult to assign an origin with certainty. One of the best criteria is compositional, because it is highly unlikely that essentially monomineralic dikes and sheets could be anything other than cumulate material, however, many pyroxene-oxide veins may represent late interstitial liquids filter pressed into local accumulations. These could still have cotectic compositions if it is assumed that plagioclase continued to grow on wall rock crystals rather than forming new nuclei.

Mafic phases of the anorthosite were investigated by Ashwal (1978, 1982) and are discussed in Stops 7 and 8. These rocks range from mafic gabbro and norite to oxide-pyroxene rich rocks containing only 20-30% plagioclase (AN_{25-30}). In the oxide-rich facies, emerald green, calcium-rich pyroxene generally dominates over calcium-poor pyroxene, but the reverse is not uncommon. In the more mafic facies, calcium-poor pyroxenes exhibit the exsolution habit of inverted pigeonite in the more mafic facies, although metamorphic recrystallization has reduced many pyroxenes to granular intergrowths of augite and hypersthene whose primary habit is indeterminate. Both Ashwal (1978, 1982) and Buddington (1953) report the occurrence of fayalite in extremely iron-rich compositions. Fe-Ti oxides increase in abundance as iron increases and form an interstitial pattern between

Table 4a. Mineral Composition of Anorthosite Series* (Wt Per cent)

	ANDESINE	MICROCLINE	HYPERSTHENE	AUGITE	HORNBLEND	BIOTITE	MAGNETITE AND ILMENITE	GABRIT	QUARTZ	APATITE	SPHENE	CLORITE, EPIDOTE, CARBONATE ETC.	PYRITE	SPINEL	OLIVINE
ANORTHOSITE															
1.....	93.5	2.6	2.8	0.2	0.5	0.2	0.2	Tr.
2.....	88.8	4.2	0.9	1.1	0.7	3.2	0.8	0.1
GABBROIC ANORTHOSITE															
3.....	81.4	2.0	2.7	7.8	0.1	5	0.3	0.7
4.....	77.2	5.1	1.4	14.3	0.3	0.5	0.4	0.7
ANORTHOSITIC GABBRO-NORITE															
5.....	72	14.2	7.6	1.6	4.5
6.....	72.2	2.2	9.8	10.7	3.9	1.2	Tr.
GABBRO, GABBRO-NORITE AND NORITE															
7.....	56.6	1.9	6.7	15.7	14.8	0.8	3.5
8.....	59.9	3.7	20.9	7.0	7.1	0.8	0.3	0.3
9.....	45	2.7	1.6	16.8	15.1	13.5	0.3	3.0
10.....	46.3	1.5	10.8	11.7	12.5	11.9	3.3
11.....	59.9	5.5	22.6	9	3
12.....	53.6	6.0	0.3	24.9	15.1	0.1
MAFIC FACIES OF GABBRO, GABBRO-NORITE AND NORITE															
13.....	29.8	2.3	14.4	11.0	27.5	6.6	0.3	7.8	0.3
14.....	21.6	24.7	31.5	0.7	20.0	0.9	0.7
15.....	18	37	14.0	14	10	7
16.....	21.2	9.7	50.0	15.4	3.4	0.3
17.....	25	1	9	25	11	9	18
ULTRAMAFIC FACIES															
18.....	9	18	1	24	37	2	9
19.....	2.8	19.2	41.7	35	0.3	0.5	0.5
20.....	4	0.5	0.1	4	0.2	85.8	4.8	0.6

- 1 Average of 20 thin sections of anorthositic rocks from outcrops along road from Saranac lake to Tupper lake.
- 2 Cut on railroad, one mile west of Saranac station.
- 3 West headland of Boat bay, Saranac lake.
- 4 Eastern part of Baker mountain.
- 5 One-quarter of a mile east of "lock" between Lower and Middle Saranac lakes.
- 6 Two miles southwest of Gabriels.
- 7 Two and three-tenths miles northeast of Lake Clear.
- 8 One and seven-tenths miles west of Gabriels.
- 9 One-half of a mile northeast of McCauley pond.
- 10 Three-fifths of a mile northeast of McCauley pond.
- 11 One mile northwest of Shingle bay, conformable layer in anorthosite.
- 12 One mile northwest of Shingle bay, conformable layer in anorthosite.
- 13 One mile west northwest of Gabriels, mafic gabbro, incloses blocks of anorthosite.
- 14 North end of Lake Clear, the mafic gabbro incloses blocks of anorthosite.
- 15 Three-fifths of a mile northeast of McCauley pond.
- 16 One mile northwest of Shingle bay, conformable layer in anorthosite.
- 17 Seven-tenths of a mile east of north end of McCauley pond.
- 18 Three-fourths of a mile east of north end of McCauley pond.
- 19 Three-fourths of a mile northwest of Shingle bay.
- 20 One-quarter of a mile east of lock between Lower and Middle Saranac lakes.

* From Buddington (1953)

Table 4b. Chemical Analyses and Norms of Members of Anorthositic Series*

	1	2	3	4	5	6	7	8
SiO ₂	53.55	55.51	55.03	54.55	56.40	50.93	33.85	39.01
Al ₂ O ₃	24.10	25.41	25.56	22.50	24.11	16.91	10.97	5.92
Fe ₂ O ₃	1.24	.69	.75	1.31	.60	1.69	6.60	6.58
FeO.....	2.26	1.55	1.59	3.89	2.16	9.27	19.80	18.13
MgO.....	1.34	1.34	1.02	1.01	.41	5.25	4.80	10.65
CaO.....	9.64	9.36	9.56	7.81	8.06	8.34	8.73	9.90
Na ₂ O.....	4.62	4.84	4.67	4.61	5.01	3.13	1.98	.79
K ₂ O.....	.94	.94	1.09	1.93	1.93	1.09	.72	.15
H ₂ O ⁺41	.16	.28	.48	.35	.19	.55	.22
H ₂ O ⁻11	.06	.03	.08	.07	.01	.28	.05
CO ₂15	°	.13	.14	°	.31	°	°
TiO ₂	1.63	.21	.43	1.12	.44	2.54	7.43	8.18
P ₂ O ₅	°	°	.09	.35	.25	.23	3.66	.07
S.....	°	°	.01	.03	°	°	°	°
MnO.....	°	°	°	°	.04	.17	.29	.34
	99.99	100.07	100.24	99.81	99.83	100.06	99.66	99.99
Quartz.....	1.77	1.26	1.86	1.98	1.77	1.05	°
Orthoclase.....	5.56	5.56	6.67	11.12	11.12	6.67	4.45	.89
Albite.....	38.89	40.87	39.40	38.77	42.44	26.20	14.77	6.81
Anorthite.....	42.15	44.76	45.30	35.31	37.53	28.91	18.90	12.19
Diopside.....	3.72	1.36	°	.23	.71	7.55	2.31	29.67
Hypersthene.....	2.00	4.60	4.18	6.61	3.47	21.06	9.41	19.35
Olivine.....	°	°	°	°	°	°	15.42	5.62
Magnetite.....	1.97	1.00	1.05	1.86	.93	2.55	9.51	9.51
Ilmenite.....	3.04	.39	.84	2.13	.84	4.86	14.14	15.50
Apatite.....	°	°	.20	.84	.60	.54	8.57	.17
Calcite.....	.34	°	.30	.30	°	.70	°
Fenics.....	10.73	6.96	6.27	11.67	5.95	26.02	59.39	79.82

- * The data for this table with exception of No. 8 are taken from report by Buddington on Adirondack Igneous Rocks and their Metamorphism.
- 1 Anorthosite (Marcy type); road cut at southwest end of Lake Clear (St Regis quadrangle), one-fourth of a mile east of outlet of Lake Clear. Composed of coarse andesine (Ab₂₀An₈₀), augite and a trifle hypersthene. Analyst, A. Willman.
 - 2 Anorthosite (Marcy type); road cut (old road) at extreme southwest corner of Saranac quadrangle. Composed of coarse andesine (Ab₂₀An₈₀) and hypersthene with a little augite and accessory magnetite, ilmenite and a trifle apatite. Analyst, A. Willman.
 - 3 Anorthosite (Marcy facies); analysis of composite grab sample of 60 fragments from ten localities in core of St Regis-Marcy dome along road from Algonquin (Saranac quadrangle) to half a mile northwest of Rustic Lodge (St Regis quadrangle). Analyst, R. B. Ellestad. Modal mineral composition given in table 1.

- 4 Gabbroic anorthosite (Whiteface facies); composite grab sample of ten specimens from exposures on a five-mile length along strike of border facies between Lake Flower and north of McCauley pond. Analyst, R. B. Ellestad.
- 5 Anorthosite (member of border Whiteface facies); first cut (about one mile) west of Saranac Lake station on New York Central and Hudson River railroad between Saranac Lake and Saranac Junction. Fine-grained equigranular rock speckled with red garnets. Analyst, A. Willman. Modal mineral composition given in table 2.
- 6 Norite, one and seven-tenths miles west of Gabriels. Analyst, R. W. Perlich. Modal mineral composition given in table 6.
- 7 Mafic metagabbro, two-thirds of a mile east of McCauley pond. Analyst, A. Willman.
- 8 Ultramafic facies, on road three-fourths of a mile northwest of Shingle Bay. Analysts, B. Smith and R. B. Ellestad.

TABLE 5a Average Modes of Massive Core (Marcy) Anorthosite *

N=48

Mineral	\bar{x}_i	δ	δ_m	n
Plagioclase ¹	83.88	14.11	2.04	48
Clinopyroxene	6.27	7.93	1.14	36
Hornblende	2.43	2.33	0.37	33
Hypersthene	2.89	9.79	1.41	15
Garnet	1.21	3.62	0.52	17
Diopside ²	0.46	—	—	28
Chlorite	1.74	—	—	40
Quartz	0.08	—	—	5
Potassic feldspar	0.19	—	—	7
Scapolite ³	0.46	—	—	8
Sphene	0.14	—	—	13
Apatite	0.18	—	—	25
Epidote group	0.11	—	—	4
Calcite	tr	—	—	8
Magnetite	0.73	2.06	0.30	37
Ilmenite	0.16			
Pyrite ⁴	0.03	—	—	11
Color index	16.03	—	—	—
An content plagioclase	56.65	9.21	1.33	—

*From Crosby (1969).

TABLE 5b Average Modes of Border Facies (Whiteface) *
Anorthosite

N=100

Mineral	\bar{x}_i	δ	δ_m	n
Plagioclase ¹	74.77	21.14	2.11	100
Clinopyroxene	9.60	10.52	1.03	88
Hornblende	8.04	9.34	0.93	89
Hypersthene	0.71	1.89	0.19	17
Garnet	3.23	8.81	0.88	28
Biotite ²	0.82	—	—	46
Chlorite	0.62	—	—	50
Quartz	0.27	—	—	9
Potassic feldspar	0.28	—	—	11
Scapolite ³	0.14	—	—	5
Sphene	0.28	—	—	55
Apatite	0.20	—	—	70
Epidote group	0.06	—	—	10
Calcite	tr	—	—	4
Graphite	0.02	—	—	5
Magnetite	0.81	1.53	0.15	71
Ilmenite	0.06			
Pyrite ⁴	0.03	—	—	41
Color index	21.02	—	—	—
An content plagioclase	54.85	9.04	0.90	—

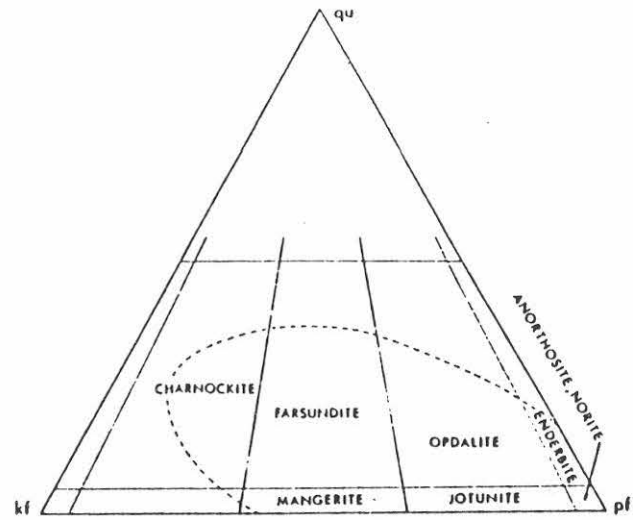

FIGURE 18 Nomenclature and classification of rocks of the anorthosite-charnockite suite. From deWaard (1969).

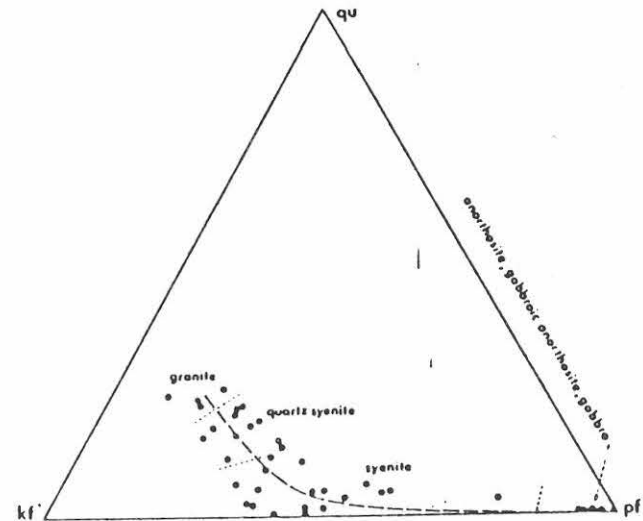

FIGURE 19 Qu-kf-pf diagram showing modal compositions and nomenclature of rocks of the Marcy massif. From deWaard (1969).

pyroxene grains and sparse plagioclase. In rocks containing high concentrations of P_2O_5 (2-3.5%), apatite grains occur within the oxides and to a lesser extent within the pyroxenes.

The evolution of the gabbroic to ultramafic rocks described above appears to be satisfactorily accounted for by removal of intermediate plagioclase from gabbroic anorthosite (Ashwal 1978). This model is consistent with those presented by several authors, McLelland et al. (1992a,b). Less certainty exists with regard to the detailed, late evolution of these magmas. For example, Ashwal (1978) proposed that Fe, Ti-oxides began to crystallize when the original magma was 80% crystallized (72% plagioclase, $[Ab_{33}An_{41}Or_6]$; 16% Augite, $Wo_{36}En_{41}Fs_{23}$; and 12% pigeonite, $Wo_{11}En_{57}Fs_{32}$) and concluded, therefore, that the magnetite-ilmenite deposits of the Adirondacks represent cumulates and re-mobilized cumulates. However, both Lindsley (1992) and Epler (1987) provide compelling arguments for the role of liquid immiscibility in the origin of these deposits. Where less evolved fractions of these liquids aggregate into discrete bodies, they form high Fe-Ti gabbros such as those (see table 10) at Sanford Lake (Kelly 1979), Lincoln Pond (Kemp 1910), or Woolen Mill (Kemp 1910). Upon extreme fractionation, to the point of liquid immiscibility, these gabbros can yield economic concentrations of magnetite-ilmenite ore.

In closing this section, we note again the existence of dikes and sheets which are essentially ultramafic or monomineralic in composition. Notable examples are the pyroxenite (opx>>cpx) dike in Roaring Brook on Giant Mt. (see Stop 1 and table 10 for chemical analysis). deWaard (1968) and Ashwal (1978, 1982) have suggested that dikes consisting essentially of pyroxene(s) must represent mobilized cumulates. Good evidence for cumulate layering does exist and this process is clearly important in the evolution of the massif. However, some of the pyroxenite dikes may represent the silicate fraction of immiscible silicate-oxide melts (see Stop 14).

B) Granitoids of the Massif

As noted by all investigators, Proterozoic anorthosite complexes are commonly associated with a distinctive suite of mildly alkaline, Fe-enriched granitoids referred to by Vorma (1971) and Emslie (1978) as the rapakivi-suite. Together with associated anorthosites, these rocks constitute the AMCG suite (Emslie 1978, 1985) or the anorogenic trinity of Anderson (1983). The granitoids are dominated by mangeritic to quartz-mangeritic varieties transitional to charnockites and also comprise a lesser volume of hornblende granite and fluorite-bearing alaskite (table 3, figs. 18,19).

Near their contact with the anorthosites, these granitoids show evidence of mixing with a variety of anorthositic magmas, including late ferrodiorites, to produce a group of complex, intermediate types ranging from jotunite to so-called Keene Gneiss (Stop 5). Buddington (1939, 1953) classified many of these rocks as mafic pyroxene syenite and Davis (1971) referred to them as transitional rocks that occur in a zone on the order of ~1 km wide surrounding the anorthosite. Davis presented analytical evidence that within the transitional rock pyroxene compositions exhibit no correlation with the mafic content of the rock. This is in contrast to well-established correlations within both anorthositic and granitoid members of the AMCG. The absence of correlation is interpreted (Davis 1971) as evidence for magmatic mixing in the transitional zone. McLelland (1990) and McLelland and Whitney (1990) point out that, on binary variation diagrams, these transitional rocks plot between granitoid and anorthositic trends (see black triangles, fig. 10). Pyroxenes of the rocks occupy a transitional region (fig. 22). All of these properties provide a sound observational basis for interpreting the transitional rocks, or Keene Gneiss (Stop 5), as the result of mixing of magmas. If jotunites are understood to be chemically equivalent to mixtures of noritic and mangeritic magma, then they fall into the classification along with the transitional rocks.

As summarized by McLelland (1990) and McLelland and Chiarenzelli (1990), there has been a long debate concerning the relationships of anorthositic and granitoid members of the AMCG. Buddington (1972), Davis (1971), Ashwal (1978), McLelland (1990), McLelland and Whitney (1990), and McLelland and Chiarenzelli (1990) all present evidence for coeval, but non-comagmatic, relationships between anorthositic and granitoid members of the AMCG. As discussed previously, this evidence is based upon the observation that the two major branches of the AMCG exhibit a discontinuity at SiO_2 ~55-60% (Daly Gap) on Harker variation diagrams, and, moreover, show different senses of differentiation on these diagrams (fig. 10). As stressed by Buddington (1972), the anorthositic rocks evolve towards high-FeO and low- SiO_2 while the granitoids evolve towards high-FeO and high- SiO_2 .

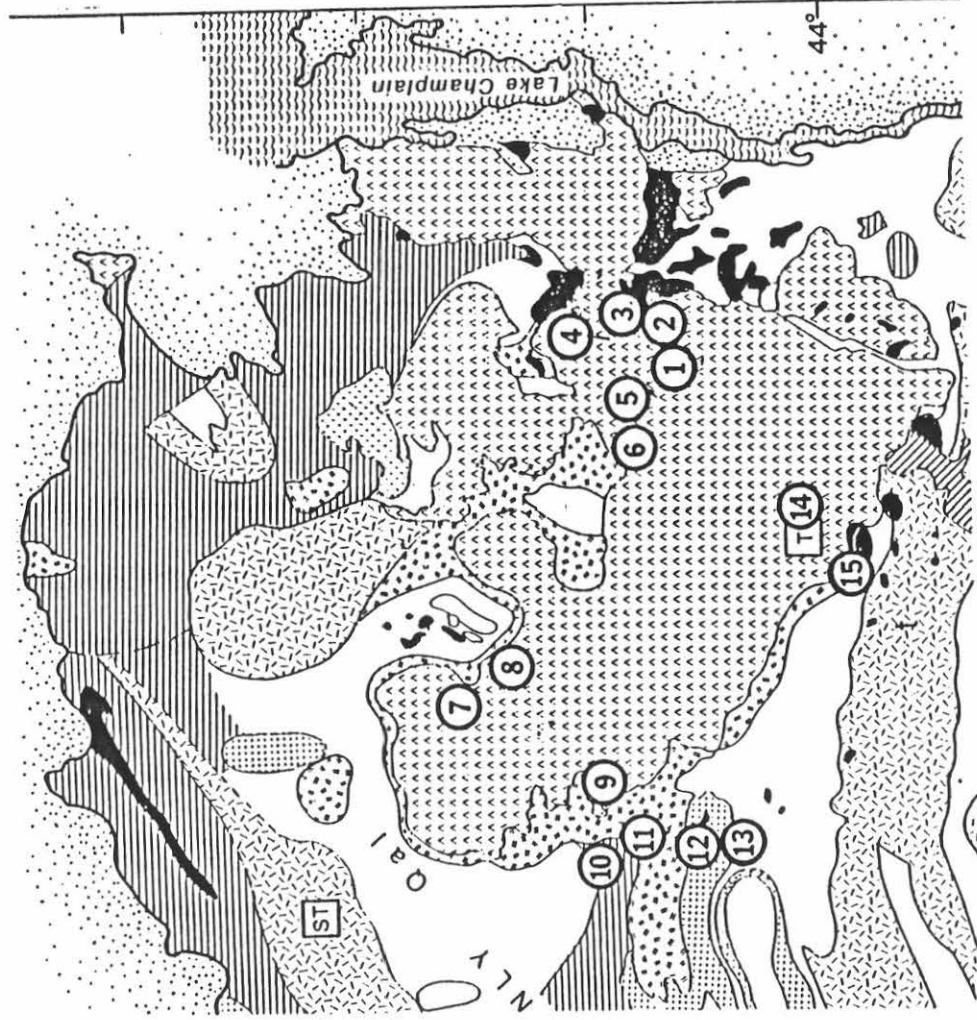

Figure 20. Location for stops with the Adirondack Highlands. See Figure 2 for identification of map patterns.

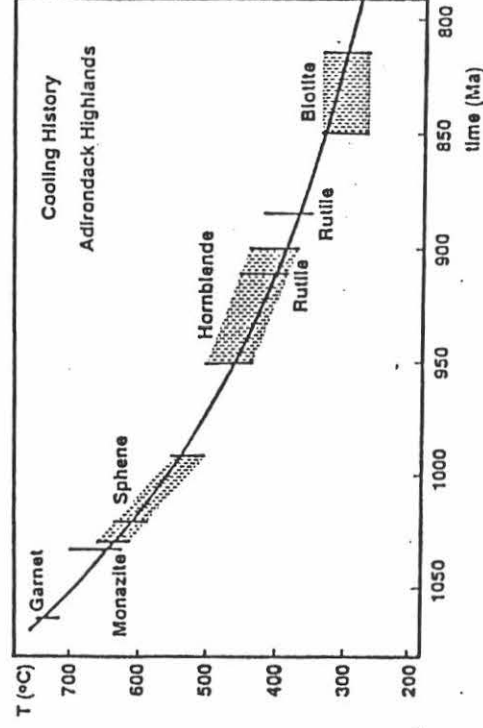

Figure 21 Cooling history of the Adirondacks (After Mezger et al. 1991).

ROAD LOG

DAY 1 Giant Mt., Woolen Mill Gabbro, Lake Clear Ferrogabbros

Miles Cum

0.0	0.0	Leave Colgate Camp. Turn north (right) on Rt. 30.
0.8	0.8	Road to Saranac Inn on east side of Rt. 3.
0.3	1.1	Passing golf course.
1.8	2.9	N.Y.S. Fish Hatchery.
0.6	3.5	Forest Home Road turn east (right).
3.7	7.2	Junction with McMaster Road continue east.
1.9	9.1	Ferrogabbro layers in anorthosite just east of sharp curve. These are probably cumulates.
2.6	11.7	T-intersection. Turn right, then immediately left.
0.3	12.0	Junction with Rt. 3, turn north (left) towards Saranac Lake.
1.1	13.1	Stop Light.
1.3	13.3	Traffic circle. Head east on Rt. 86.
6.2	19.5	Turn right on Old Military Road towards Keene and the Olympic Ski Jump.
3.7	23.2	Olympic Ski Jump to south of road. Merge left with Rt. 73; continue east.
7.2	30.4	Cascade Lakes. Cascade slide directly across lakes and above high waterfall.
6.0	36.4	Junction of Rts. 73 and 9N in Keene. Continue south (right) towards Keene Valley on Rt. 73.
1.3	37.8	Junction with 9N to Elizabethtown.
2.8	40.6	Bridge over John's Brook, Keene Valley.
2.2	42.8	Bridge over Ausable River
0.3	43.1	Saint Hubert's.
0.9	44.0	STOP 1. Trailhead of Roaring Brook Trail on Giant Mt. Return to Rt. 73 and turn northwest (right) back towards Keene Valley and Keene.

STOP 1 Roaring Brook on Giant Mt.

The valley of Roaring Brook provides some of the finest exposures of AMCG rocks in the Adirondack region. According to deWaard (1970), torrential rains on June 29, 1963 resulted in flooding that exposed the fresh, smooth outcrops along the brook. Presumably, relationships of the sort seen in Roaring Brook would be more widely reported if similar exposures existed elsewhere. On the other hand, the nature of the geology exposed in Roaring Brook suggests that the events that took place here were uncommon, i.e., dikes of several different compositions and/or generations have intruded parallel to the stream valley and a variety of AMCG rock types are represented. A plausible interpretation of the association is that Roaring Brook represents a zone of weakness that has repeatedly served as a magma conduit in the past.

From 1400' to 2000' the brook is underlain by a variety of anorthositic and gabbroic rocks. Generally the gabbroic facies contains two pyroxenes but both augite gabbros and norites are well represented and difficult to distinguish with the naked eye. Near the lip of the high waterfall (note diabase dike in stream bed) a broad (~3m) somewhat irregular, monzonite dike occupies the northwest side of the brook. The contact of this lens-like body with anorthosite is easily recognized once identified. The monzonite contains augite and blue-grey micropertthite and closely resembles the anorthosite. The dike is foliated parallel to its margins and crosscuts a N20-40W, 60-80N foliation in the anorthosite. Inspection of the anorthosite reveals that subophitic pyroxenes have not been deformed, and therefore, the foliation was imposed prior to complete solidification of the magma. A reasonable foliation-producing mechanism consistent with these observations would be compaction, within the magma chamber, of randomly oriented plagioclase crystals in a fashion similar to the collapse of a house of cards. Presumably the collapse would be accompanied by filter pressing of pyroxene-rich interstitial liquid. This is consistent with the commonly observed "intrusion" of pyroxene into cracks in plagioclase. It is further suggested here that many of the numerous small pyroxene- and oxide-rich veins, pods, and lenses that characterize the anorthosite massif have this origin. A number of these are present in Roaring Brook.

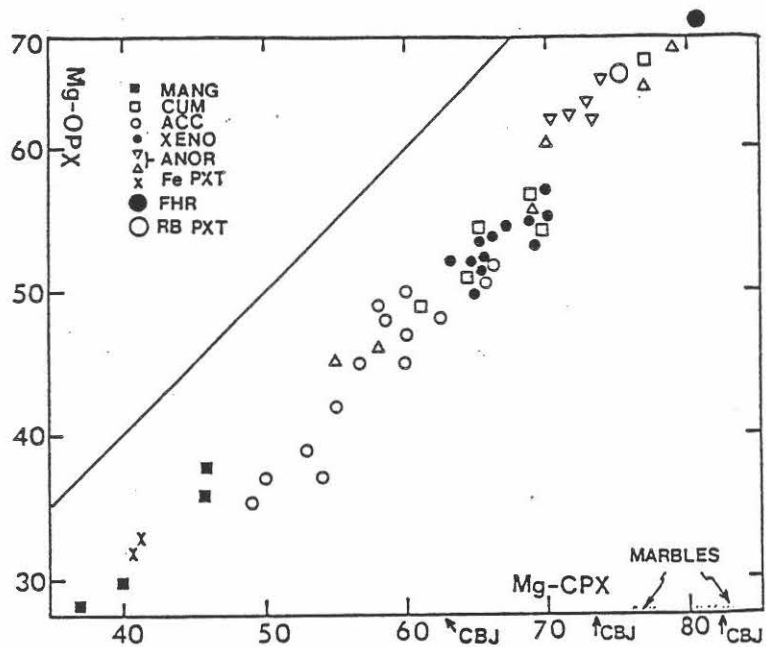

Figure 22. Plot of mole fraction of Mg ($Mg/Mg + Fe$) for opx vs. that for cpx for anorthositic (ANOR) and mangeritic (MANG) rocks for the Marcy massif. Also: CUM = cumulate enclaves; ACC = pyroxene pairs with acicular opx; RB PXT = Roaring Brook pyroxenite dike; Fe PXT = iron-rich pyroxenite, Roaring Brook; XENO = dioritic xenoliths, Roaring Brook; FAR = Forest Home Road; CBJ = pyroxenite dikes in Ausable River, Jay.

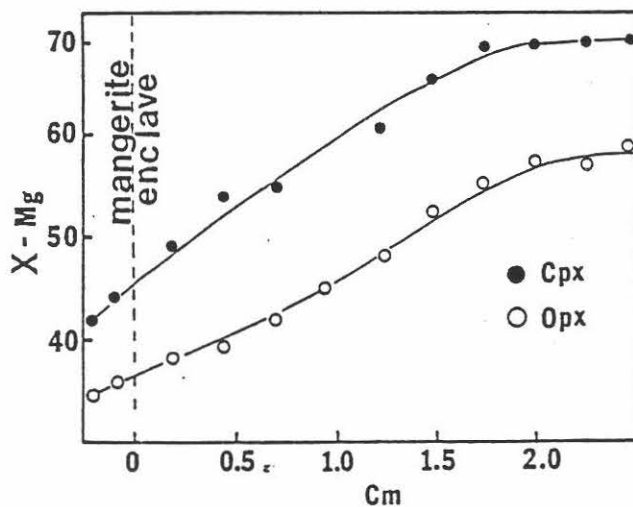

Figure 23 Plot of mole fraction of Mg ($Mg/Mg + Fe$) for both cpx and opx across the contact of mangerite with an enclave containing acicular opx.

Proceeding upstream from the lip of the high falls, several steep walled pools are encountered and finally a 3-10 meter-high cliff crosses the brook and results in a second waterfall. At the base of the waterfall there is exposed a dark, meter-wide, eroded dike of pyroxenite. Downstream this dike splays and pinches out, but upstream it defines a pronounced erosional channel in the cliff and then continues upstream for another 30-40 m until it is lost beneath cover. In fact, the dike is discontinuous and is intermittently exposed for almost a kilometer. The chemical composition of the dike is given in table 6. Orthopyroxene dominates the mode but clinopyroxene is also present, as is minor plagioclase and magnetite-ilmenite. Texturally, the orthopyroxenes are large and appear to be of cumulate origin with narrow accumulate overgrowths. Finer-grained plagioclase is interstitial to the orthopyroxenes. Clinopyroxenes occur both as large grains and interstitially, but mainly in the latter mode. Magnetite-ilmenite occurs both interstitially and within pyroxenes but in both instances appear to be late in the crystallization sequence and to occupy spaces whose shape is defined by other minerals.

The pyroxene dike is enigmatic. It is clearly intrusive and was emplaced after the anorthositic rocks acquired their foliation. In several instances xenoliths of anorthosite occur within the dike. Conversely, as noted by deWaard (1979, p. 2072), the anorthositic rocks crosscut the dike at several places, and soft contacts between the dike and country rock are not uncommon, indicating that the rocks are coeval. Because of the dike's composition, it seems unlikely that it was intruded as a liquid. This is consistent with the cumulate and adcumulate textures. About the only remaining possibility is that the dike represents a mobilized, intruded cumulate (deWaard 1970, Ashwal 1978, 1982) together with minor remaining liquid. If so, the intrusion must have taken passively so as to avoid any semblance of preferred orientation among grains. A possible mechanism would be the downward draining of a cumulate layer into an underlying fracture developed in cooling anorthosite. The very high Mg-numbers of the pyroxenes in the dike (Opx-65, Cpx-75, fig. 22) suggest that the cumulate formed early in the fractionation history. Finally we note that least square mixing calculations demonstrate that removal of ~95% plagioclase (AN_{45}) from norite yields a composition closely resembling the orthopyroxene dike (table 6). This is consistent with the suggested cumulate origin of the pyroxenite dike.

The smooth outcrop surfaces surrounding the pyroxenite dike are dominated by gabbroic anorthosite transitional to gabbro and provide excellent examples of the composite nature of the anorthositic suite. Several stages in the evolution of the massif are recorded in crosscutting relationships. The oldest anorthosite facies recognizable are coarse grained rafts of blue-grey andesine anorthosite corresponding to the Marcy facies. These are clearly visible on the outcrop. They occur as xenoliths within a subophitic, medium-grained two-pyroxene gabbro, or anorthositic gabbro, which locally, grades into a noritic facies. This, in turn, is crosscut by a fine grained gabbroic anorthosite similar to the Whiteface facies. Elsewhere on the outcrop, the time sequence is partially reversed and the fine grained anorthositic rock is crosscut by gabbroic to noritic facies; however, in all instances, the rafts of coarse, blue-grey anorthosite appear to be oldest rock. An apparently older, fine grained gabbro occurs as xenoliths within fine-grained gabbroic anorthosite near the upper edge of the cliff that defines this level of Roaring Brook.

The Roaring Brook pyroxenite dike clearly crosscuts all facies of the surrounding anorthositic rocks and the foliation within them. However, it is itself crosscut by ~10 cm wide dikes of gabbroic material. In addition to previously cited evidence, this observation fixes the pyroxenite dike as coeval with the anorthositic rocks and helps to explain the mutually crosscutting relationships and soft contacts are observed. Note that staining has revealed a small component of monzonitic and granitic material occurring together with the latest gabbroic dikes.

Returning to the trail and proceeding uphill, we cross Roaring Brook and ascend the summit trail to the 2260' (689m) level. Here we leave the trail and descend to water-smoothed pavement outcrops in the brook valley. The outcrops expose a spectacular intrusion breccia consisting of rounded and angular blocks (10-30 cm on average) which include coarse, white anorthosite but consist mostly of grey to black, medium to fine-grained, granular pyroxene-feldspar assemblages. These are set in a medium grained groundmass ranging in composition from gabbroic anorthosite to garnetiferous mangerite and ferrogabbro. These matrix rock types are highly mingled and difficult to separate without the aid of outcrop staining.



(a)

JM 7-18-8



(c)

BMK 81-76B

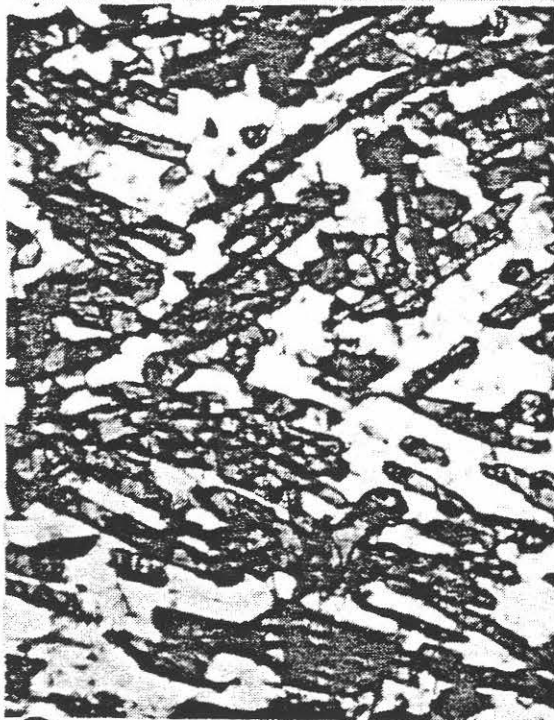

(b)

JM 8-29-17C



(d)

BMK LA55-79-18

Figure 24 Comb textures formed by acicular orthopyroxenes in enclaves at Roaring Brook (*a* and *b*) compared with known comb textures with acicular opx (Sierra Nevada plutons) studied by Brooks McKinney.

Although the intrusion breccia is dominated by dark enclaves, white inclusions of anorthosite are easily recognizable. Less easy to recognize, however, are pink, somewhat glassy, blocks that might be mistaken for garnetiferous quartzite but turn out to be fine-grained, oxide-rich garnetiferous anorthosite or gabbro.

A number of dark inclusions exhibit narrow (~.5 cm), light colored layers. These have traditionally been interpreted as primary in origin and led to the assignment of a metasedimentary origin to the rocks (Kemp 1921, deWaard 1970, Jaffe et al. 1983, McLelland et al. 1986). However, staining of slabs taken from these occurrences indicate that the layers consist essentially of mesoperthitic syenites and mangerite, some of which can be traced continuously into host rock. Additionally, many of these layers are associated with acicular orthopyroxenes extending outward from the pyroxene-plagioclase assemblage that constitutes the dark layers (fig. 24). The pyroxene-plagioclase assemblages are essentially gabbroic to dioritic in composition with subequal amounts of pyroxene ($X_{Mg}^{OPX} = .35-.55$, $X_{Mg}^{CPX} = .50-.70$) and plagioclase (AN_{25-40}). Igneous textures, including acicular orthopyroxene, are common within these layers. On the basis of these textures and compositions, we interpret these layered inclusions as igneous enclaves intruded by parallel veins of syenite and mangerite and incorporated into the mixtures of country rock magmas now constituting the breccia groundmass. The acicular orthopyroxenes are identical to comb textured pyroxenes in demonstrably igneous rocks such as orbicular granites (McKinney 1990) and provide compelling evidence for the igneous nature of these rocks (fig. 24). Note that the often "slumped" configuration of the layering in these rocks is also consistent with their evolution from magmas.

The non-layered inclusions in the Roaring Brook intrusion breccia are also interpreted as igneous in origin. The most compelling evidence for this is the presence of acicular orthopyroxenes within these enclaves (fig. 24), but other observations include rock and mineral compositions which do not correspond closely to possible sedimentary precursors such as calcsilicates, but in many cases are similar to dioritic rocks. Note, for example, that in Adirondack calcsilicates the pyroxenes consist almost solely of clinopyroxene and that these are generally more Mg-rich than the clinopyroxene in the Roaring Brook enclaves (fig. 22). In addition, the enclaves never contain calcite, quartz, wollastonite, garnet, graphite, or phlogopite; all of which are common in calcsilicates. Finally, we note that "soft" and lobate contacts between the enclaves and country rocks similar to those typical of coeval, commingled magmas such as proposed here. Indeed there exist several examples in the brook where dark enclaves can be seen in the process of formation as the result of disruption of masses of mafic rock by felsic country rock. These "soupy" masses are of the same composition as the dioritic mafic enclaves and are believed to represent their sources.

In addition to dioritic to gabbroic enclaves, the intrusion breccia contains a number that are pyroxenitic and, in particular, are clinopyroxene rich. These are shown by filled circles on fig. 25. The most magnesian of all the enclaves is 7-18-89-2 which is a clinopyroxenite (fig. 25). Texturally and compositionally the pyroxenitic enclaves are interpreted as xenoliths of cumulate material caught up and disrupted by ascending AMCG magmas. Consistent with this interpretation is the 130 ppb platinum concentration of 7-18-89-2. This, and other possible cumulate enclaves, are designated as such on fig. 25. Note that these enclaves do not contain acicular pyroxene and consistently exhibit large, interlocking pyroxene grains with minor interstitial plagioclase. Within some of the larger masses of dark material both dioritic and cumulate pyroxenite coexist thus indicating a genetic relationship between the two types.

In order to better constrain the evolution of the enclaves, we have plotted their chemistry in binary variation diagrams with MgO chosen as a common variable (fig. 25), because it, more than SiO₂, varies with fractionation in mafic rocks. The most important conclusion emerging from these plots is that magma-mixing appears to have taken place - both with regard to the enclaves and with regard to the breccia matrix. Several of the variation diagrams, and especially SiO₂ vs. MgO, show a pronounced linear plot of country rock jotunite, mangerite, and charnockite. We interpret this to mean that the intermediate rock types represent mixtures of the other magmas. Here it must be stressed that the jotunites are not necessarily the most primitive of the felsic rocks; they are likely to be the result, despite their position in these plots, of mixing of ferrodiorites and mangeritic magma.

In the binary plots (fig. 25) the rocks interpreted as cumulates lie approximately along a straight line for most oxide variation. Moreover, they head, in most instances, towards anorthositic and jotunitic rocks. This is consistent with the field-based observation that the (analyzed) examples of

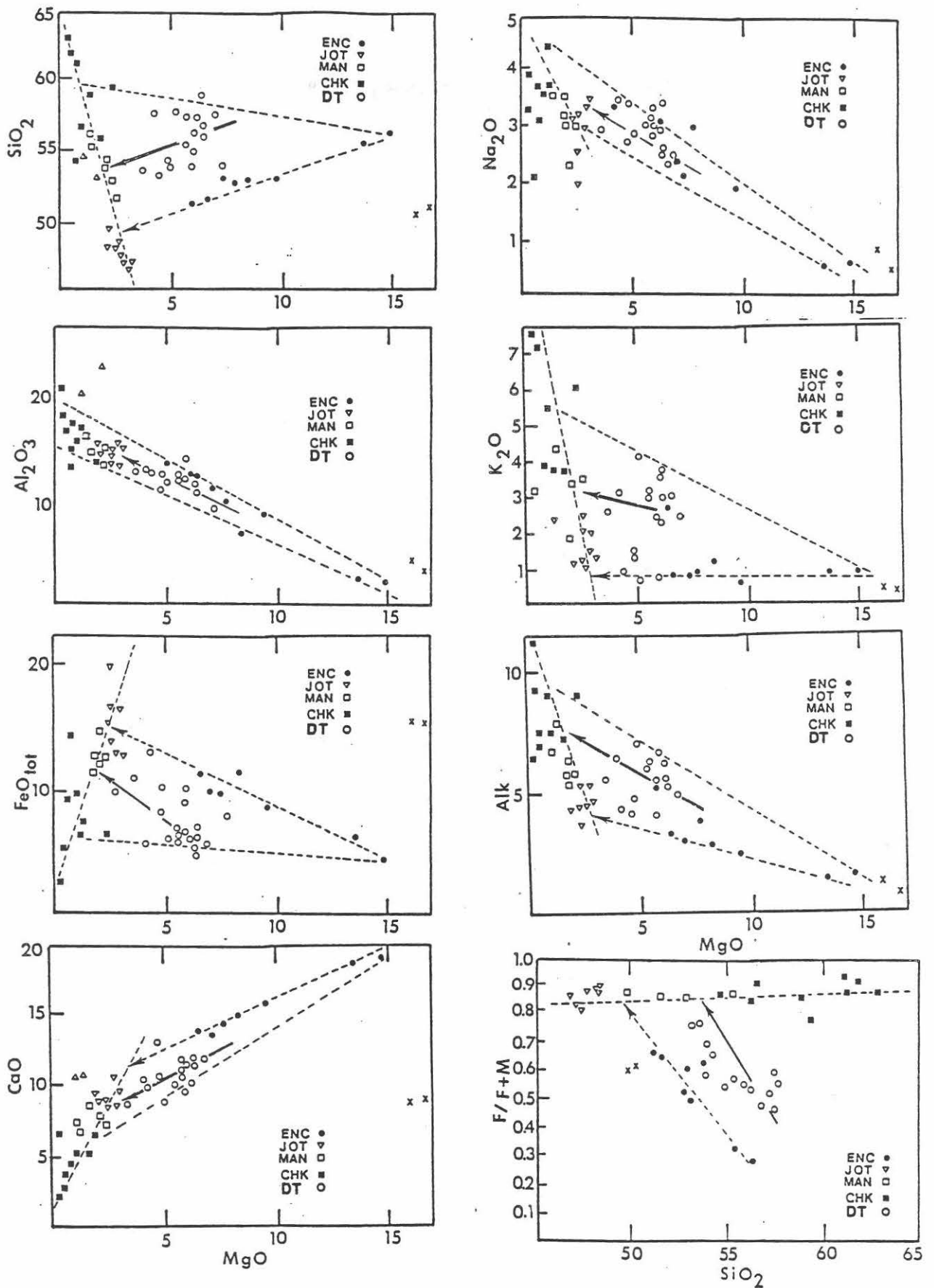

Figure 25 Binary variation diagrams for enclaves and host rocks in Roaring Brook intrusion breccia. ENC = cumulate-type enclaves; DT = dioritic enclaves; MAN = mangerite; CHK = charnockite; JOT = jotunite; X = pyroxenite dike (opx-rich).

these rocks were found in, and collected from, jotunitic and anorthositic matrixes. Therefore, they had no opportunity to mix with granitic material. In addition to this, their cumulate nature, including partial solidification, would have inhibited mixing. However some mixing did take place and this is convincingly documented by plots involving Al_2O_3 and CaO which show a greater range in the enclaves than in the host rocks.

TABLE 6
Major Element Analyses of Roaring Brook Samples

Sample	1	2	3	4	5	6	7	8	9	10
	Marcy-type Anorthosite ^a	Whitface Anorthosite ^a	Anorthosite 7-19-89-27	Leuconorite 7-19-89-20	Fine Grained Gabbroic Anorthosite 7-19-89-21	Gabbro 7-19-89-22	Gabbro 7-19-89-23	Small Mafic Inclusions 7-19-89-25	Orthopyroxenite Dike	Jotunite
SiO ₂	54.54	53.54	54.97	52.55	53.75	53.70	53.19	53.29	50.82	47.16
TiO ₂	0.87	0.72	.30	.49	.23	.21	.43	.30	1.27	2.20
Al ₂ O ₃	25.81	22.50	25.09	21.48	25.23	26.54	21.66	23.24	4.7	17.23
Fe ₂ O ₃	1.00	1.26	1.05	1.13	2.18	1.05	4.07	3.31	2.3	2.75
FeO	1.26	4.14	1.19	3.01	---	---	---	---	14.2	9.24
MnO	0.02	0.07	.02	.06	.02	.01	.06	.04	0.29	0.15
MgO	1.03	2.21	.68	3.96	1.84	.71	3.9	2.76	16.52	2.71
CaO	9.92	10.12	9.95	11.79	10.93	10.40	11.43	11.82	8.44	9.04
Na ₂ O	4.53	3.70	4.7	3.84	4.26	4.63	3.78	3.80	0.71	6.61
K ₂ O	1.01	1.19	1.46	.66	.75	.80	.65	.71	0.20	2.27
P ₂ O ₅	0.09	0.13	.07	.09	.06	.06	.09	.04	0.14	0.59
H ₂ O	0.55	0.12	.57	.48	.67	.49	.38	.53	0	0
Total	100.17	100.00	99.86	99.95	99.95	98.57	99.63	99.82	99.59	99.70

Sample	11	12	13	14	15	16	17	18	19	20
	Mafic Mangerite	Mangerite	Charnockite	Garnet-Plagioclase Xenolith 7-18-89-3	7-18-89-2	7-18-89-7	7-18-89-21A	7-18-89-21B	7-18-89-4	7-18-89-6
SiO ₂	50.05	56.45	62.70	49.23	55.74	52.90	52.75	53.83	57.62	55.28
TiO ₂	1.47	1.50	0.44	2.63	.17	.70	.65	.84	.73	.68
Al ₂ O ₃	16.08	15.88	18.41	16.76	2.87	5.50	10.17	12.96	13.54	12.54
Fe ₂ O ₃	2.53	2.60	0.63	2.73	5.22	13.37	8.78	11.40	6.76	7.73
FeO	9.06	8.13	2.37	12.68	---	---	---	---	---	---
MnO	0.20	0.17	0.05	.43	.83	.38	.24	.25	.11	.13
MgO	3.21	1.06	0.40	2.73	14.39	8.18	7.61	4.83	5.10	5.56
CaO	8.20	4.39	2.49	7.01	18.51	15.21	14.38	10.66	8.80	10.06
Na ₂ O	4.3	3.56	3.85	2.54	.62	1.05	3.00	3.37	2.87	3.03
K ₂ O	4.33	5.50	7.59	2.51	.9	1.2	.88	1.34	4.16	3.01
P ₂ O ₅	0.57	0.38	0.15	.77	.05	.17	.15	.23	.16	.17
H ₂ O	0	Nd	Nd	.01	.10	.10	.38	.30	---	.70
Total	100.09	99.62	00.08	100.02	100.21	98.82	98.99	100.01	99.85	98.89

^aBuddington (1939)

The dioritic enclaves exhibit substantial scatter in the variation diagrams but appear to have interacted mainly with mangeritic and charnockitic magmas, as is certainly the case with the layered varieties. Chemical analyses are given in table 6 and variation diagrams (fig. 25) demonstrate mixing of the enclaves with mangeritic to charnockitic matrix. The mixing is also recorded by the composition of acicular pyroxenes which become increasingly iron-rich near the contact with the matrix rock, thus establishing a smooth gradient with these less magnesian compositions (fig. 23).

If magma mixing and commingling exist, as described, at Roaring Brook then there are at least three, and probably four or five, magmas that have interacted. These would include charnockitic, mangeritic, anorthositic, and ferrogabbroic to ferrodioritic magmas to the matrix that ascended through the Roaring Brook conduit. The anorthositic and ferrogabbroic magmas appear to have incorporated xenoliths of clinopyroxenitic cumulates which exhibits some interaction with these magmas. The dioritic enclaves are interpreted in the manner of Wiebe (1979) for the Nain anorthositic complex. Here similar dioritic enclaves are interpreted as residual liquids filtered pressed from anorthositic magma by intruding granitic magma. The dioritic magma then chilled against the granite, forming pillows with soft, lobate contacts, etc.. Some mixing between the magmas results in linear arrays in binary variation diagrams, similar to the situation at Roaring Brook.

In addition to the enclaves described above there are present, in the downstream section of the intrusion breccia, layers and sheets of very iron rich (X_{Mg} ~.25-.30) pyroxenite which is associated with the mangeritic rocks. The origin of these sheets is unclear, but by analogy with more magnesian pyroxenites, they may represent mobilized cumulates from the mangerites.

Near the bottom of the downstream section (~700 m) the number of anorthosite xenoliths in the mangerite-jotunitic groundmass increases rapidly until the rock passes into a block structure configuration similar to that commonly developed in the Marcy massif anorthosite.

From parking area turn left (southeast) on Rt. 73

- 5.4 49.4 Junction with Rt. 9, turn left (north) on Rt. 9 towards Elizabethtown
- 2.4 51.8 STOP 2 Split Rock Falls, enter parking area.

STOP 2 Split Rock Falls

The roadcut across from the parking area provides evidence for multiple intrusions of anorthositic and gabbroic rock. The dominant rock type is gabbroic anorthosite which encloses altered xenoliths. Subophitic textures are preserved in the more gabbroic xenoliths. Garnetiferous gabbro truncates foliation in some xenoliths and has, itself, a different foliation. Some small xenoliths of anorthosite are elongated and are deformed parallel to the foliation in the gabbroic facies suggesting coeval magmatism. All of the above facies, including the garnetiferous anorthositic gabbro, are disrupted by a more mafic facies similar to Woolen Mill gabbro. Chemical analyses of representative samples are given in table 7. Late mafic dikes (Phanerozoic?) with well developed slickensides cut all other lithologies.

The outcrop not only gives good evidence for the composite nature of the Marcy anorthosite massif, but it also demonstrates the manner in which these rocks can acquire foliation during magmatism and without the need for regional strain. Numerous other localities exist in which different members of the anorthosite suite locally develop foliations which are crosscut by other anorthosite facies. The fact that these rocks involved are clearly contemporaneous, and that the fabrics are strictly local, provide compelling evidence that the foliations developed during composite magmatism when semi-consolidated blocks and magmas underwent differential movement.

- 7.7 59.5 Enter Elizabethtown, Junction Rts. 9, 9N. Continue north on Rt. 9
- 5 64.5 Village of Lewis. Turn left (west) on Wells Road
- 1.3 71.9 STOP 3 Long roadcuts in isoclinally folded complex of gabbroic, anorthositic, and granitic rocks.

STOP 3 Long outcrop of Isoclinally Folded Anorthositic and Granitic Rocks South of Elizabethtown on Rt. 9.

Although most rocks in this outcrop are highly altered, it affords the opportunity to see the effect of Ottawa deformation on AMCG rocks. Most of the outcrop consists of somewhat gneissic anorthositic gabbro. Garnet megacrysts, several cm. across, truncate foliation and may have grown under static conditions. Large black clots of hornblende contain remnant orthopyroxene cores and may represent giant orthopyroxenes. A representative analysis of the gabbroic phase is given in table 7.

- 1.3 73.2 Junction Rts. 9 and 9N in Elizabethtown. Turn left (west) on Rt. 9N.
- 1.1 74.3 STOP 4 Woolen Mill Gabbro

STOP 4 Woolen Mill Gabbro

Park on the right side of the road opposite high roadcut on left. The cut shows metanorthosite intruded by a dark, fine-grained rock, first described by Kemp and Ruedemann (1910) as the "Woolen Mill Gabbro". It is a clinopyroxene-garnet-oligoclase granulite with considerable opaque oxides and apatite, and minor K feldspar and quartz. It contains a few large, uncrushed andesine xenocrysts, probably derived from the host anorthosite. The texture is that of a granulite, but the xenocrysts have apparently escaped recrystallization or grain-size reduction, even along their margins. This peculiar situation may be explained by static recrystallization of an initially fine-grained intrusive rock. The composition of rock (table 7) is that of a somewhat K₂O rich (1.20 wt%) ferrogabbro of the type common in the Adirondack Highlands, especially near magnetite-ilmenite concentrations. It also is found associated with anorthosite at stops 7 and 8 and is

commonly present as disrupting material in block structure. Woolen Mill gabbro may represent gabbroic anorthosite magma enriched in mafic components by separation of cumulus plagioclase as suggested by mixing calculations (Ashwal 1978).

This is the type locality for deWaard's (1965) clinopyroxene-almandine subfacies of the granulite facies. Typical compositions for Woolen Mill gabbro are plotted in the ACF projection given in fig. 30b, and these make it clear that some changes in composition control the presence of small quantities of orthopyroxene.

Cross the road and examine the outcrops in the stream bed. At the west end of the stream exposures, Woolen Mill gabbro clearly crosscuts anorthosite, and veins and dikes of the gabbro extend into the anorthosite. Within the anorthosite there is well-developed "block structure" where several types of anorthosite have undergone brittle fracture before being intruded by thin dikes or veins of mafic as well as felsic material. Some of these veins are identical to the mafic granulite in the roadcut (and at the west end of the stream exposure) and are part of the anorthosite suite. Some of the disrupting material is anorthositic gabbro more commonly associated with the anorthosite as on Giant Mt. or Lake Clear. In addition, a variable amount of granitic material is present in many of the veins as revealed by straining. The relationships here suggest formation of a plagioclase-rich cumulate, which was then fractured and intruded by a later mafic differentiate. This apparently brittle behavior suggests a relatively shallow depth of intrusion. Notice also the very large (up to 10 cm) giant orthopyroxenes that occur in the anorthosite, especially near the contact with Woolen Mill gabbro.

The anorthosite in the stream bed contains the characteristic post-metamorphic alteration assemblages of calcite \pm chlorite \pm sericite that are commonly seen as late-stage, hairline vein fillings or as alteration products of Fe-Mg silicates throughout the Adirondacks (Buddington 1939; Morrison and Valley 1988b). Average values of $\delta^{18}\text{O}$ and $\delta^{13}\text{C}$ for calcite are +12.6 and -2.2 permil, respectively, which suggests that the alteration fluids were deep seated in origin and exchanged with igneous as well as metasedimentary rocks. These veins are related to the formation of some high-density, CO_2 -rich fluid inclusions and the temperatures of alteration are estimated at 300°-500°C (Morrison and Valley 1991, 1988b).

The retrograde fluids that have infiltrated the anorthosite to precipitate calcite have not significantly altered its oxygen isotopic composition. Values of $\Delta_{(\text{calcite-plagioclase})}$ range from 0.9 to 6.6, indicating that the isotopic composition of the alteration minerals was controlled primarily by the hydrothermal fluid and that the $\delta^{18}\text{O}$ of the host rock remained largely unchanged due to low fluid/rock ratios.

Values of $\delta^{18}\text{O}$ (plag) for the "blocks" and their host anorthosite at this outcrop range from +8.5 to +9.3. In general, the metanorthosites in the NE part of the Marcy massif are somewhat more isotopically heterogeneous than those in the northwestern part of the massif, but they show the same roughly 2.5 permil enrichment in $\delta^{18}\text{O}$ relative to "normal" anorthosites worldwide (Morrison and Valley 1988a).

TABLE 7

	Split Rock Falls Gab. Anorthosite Roadcut	Rt. 9 Elizabethtown Anorthositic Gabbro Gabbroic Layers	Felsic Veining Block Structure Woolen Mill	Woolen Mill Gabbro In River
SiO ₂	51.20	41.36	60.36	45.60
TiO ₂	2.61	4.21	1.07	3.49
Al ₂ O ₃	17.67	15.96	18.26	14.23
Fe ₂ O ₃	10.43	16.43	6.62	18.42
MnO	.15	.30	.08	.27
MgO	2.53	4.91	1.06	3.07
CaO	9.37	12.83	6.45	9.25
Na ₂ O	3.10	1.90	2.67	2.63
K ₂ O	1.72	.16	2.71	.79
P ₂ O ₅	1.02	1.67	.16	1.26
H ₂ O	.27	0	.55	.70
Total	100.06	99.74	100.00	100.23

- Continue west on Rt. 9N.
 9.0 83.3 Turn right (north) on Rt. 73/9N towards Keene.
 1.8 85.1 Junction Rts. 9N and 73 in Keene. Turn left (south) onto Hulls Falls Road.
 1.2 86.3 STOP 5 Hulls Falls (Bridge). Park on south side of road.

STOP 5 Keene Gneiss at Hulls Falls

Here the East Branch of the Ausable River has exposed a typical section of hybrid anorthosite-mangerite-charnockite gneiss referred to by Miller (1918) as Keene Gneiss. The water smoothed outcrops consist of irregular, garnetiferous interlayers of plagioclase-rich and microperthite-rich gneisses with little actual mixing between them. The whole rock chemistry of several of the granitic fractions is given in table 8 (nos. 1 and 2 from Hulls Falls, no. 3 from Alden Lair):

Within the granitic facies of Keene Gneiss, blue-grey xenocrysts of andesine (An_{48}) are readily visible (Fig. 5, McLelland and Chiarenzelli 1990, reproduced in this volume) and commonly exhibit lighter-colored reaction rims of more sodic plagioclase similar in composition to that in the mangeritic host (AN_{30}). It is difficult, without staining, to distinguish the granitic and anorthositic facies of Keene Gneiss; however the anorthositic facies tend to weather whiter than the granitic facies, and the presence of quartz is diagnostic of the latter.

As Keene Gneiss is followed across strike, and towards anorthosite, the granitic fraction becomes increasingly rich in andesine xenocrysts and xenoliths of anorthosite. Ultimately the granitic fraction constitutes no more than an interstitial filling between andesine grains and the gradation into anorthosite is essentially complete (see fig. 4, McLelland and Chiarenzelli 1990).

TABLE 8

	(1)	(2)	(3)
SiO ₂	51.63	55.02	58.90
TiO ₂	3.1	1.6	1.66
Al ₂ O ₃	14.23	13.66	14.27
Fe ₂ O ₃	2.1	2.12	1.22
FeO	13.50	14.06	8.18
MnO	.16	.29	.14
MgO	2.63	.75	2.15
CaO	6.5	4.92	5.57
Na ₂ O	2.67	3.13	2.43
K ₂ O	2.41	3.93	3.57
P ₂ O ₅	.57	.52	.46
H ₂ O	.07	.08	.11
Total	99.57	98.64	98.68

The origin of Keene Gneiss seems quite clearly to be the result of commingling and hybridization between anorthositic, mangeritic, and charnockitic magmas. The high iron, titanium, and magnesium concentrations of the granitic fractions may be the result of mixing with late mafic liquids from the anorthosite. Such mixing may be responsible for the zone of mafic mangerite, gradational into jotunite, within the Tupper-Saranac complex that Buddington (1939) and Davis (1970) referred to as transition rock. In such instances magma mixing would be more complete and the resultant rock would be more homogenous than Keene Gneiss.

- 1.2 87.5 Return to Junction of Rt. 9N and 73 in Keene. Turn left on Rt. 73 towards Cascade Lakes.
 6.0 93.5 STOP 6 Cascade Slide Xenolith from the Picnic Area.

STOP 6 Cascade Slide Xenolith From the Picnic Area

Walk south across talus slope to remains of dam at base of waterfall. From this point, climb the wooden slope to the east of the falls. Use extreme caution! This is a very steep climb for about 60 m, and there are many loose rocks. In the stream bed above the falls there are several xenoliths and schlieren of marble ± calcsilicate, surrounded by anorthosite. The largest of these bodies measures approximately 30 x 200 m in exposure, is compositionally zoned, and contains several unusual minerals. Most notably, the xenolith contains sanidinite facies index minerals wollastonite, monticellite (Mo_{92-89}), and akermanite as well as cuspidine, harkerite, vesuvianite, and wilkeite (Kemp 1920; Baillieul 1976; Tracy and others 1978; Valley and Essene 1980b). Other minerals present include tremolite, garnet (Gr_{80-18} , And_{80-15}), spinel (Mg_{73}), calcite, forsterite (Fo_{92}), magnetite, clinopyroxene scapolite (Me_{78-50}), quartz, and sphene.

Field relations, deformation and geochronology make it clear that these marble bodies were entrained within the anorthositic magma before the peak of granulite facies metamorphism. The exact timing of intrusion vs. regional metamorphism is still a matter of debate. We favor pre- rather than syn-metamorphic intrusion, but in either case it is certain that both anorthosite and marble experienced the pressures and temperatures of granulite facies metamorphism (Valley and Essene 1980b). Thus, the mineralogy of these bodies may be used to study the P-T fluid conditions of granulite facies metamorphism. The origin of these minerals, which we believe was at low P and high T, is irrelevant in this regard because of the pervasive nature of the granulite overprint.

Several factors combine to make the Cascade Slide xenolith an unusually advantageous locality for fluid studies: 1) On a scale of 0.1 km the field relationships are relatively clear; a complex calcsilicate body is surrounded by anorthosite, so that any fluids infiltrating the xenolith must have passed through the anorthosite. 2) Mineral assemblages in the calcsilicates include many that either buffer or restrict $f\text{H}_2\text{O}$ and $f\text{CO}_2$. 3) There is a large contrast in $\delta^{18}\text{O}$ values between anorthosite ($\delta^{18}\text{O}=9.7$ permil; Taylor, 1969; Morrison and Valley, 1988) and the core of the xenolith ($\delta^{18}\text{O}$ up to 26.1). Thus the unusual character of this body makes it a sensitive monitor of fluid history.

Solid-solid mineral reactions at Cascade Slide indicate that P and T attained at least 7.4 kbar and 750°C, respectively (Valley and Essene 1980b; Bohlen and others 1985). Valley and Essene (1980b) describe assemblages of akermanite + monticellite + wollastonite with equilibrium metamorphic textures as well as symplectic intergrowths of wollastonite and monticellite. At these temperatures and pressures, the presence of wollastonite, monticellite or akermanite requires that $\log f\text{CO}_2$ be ≤ 4.35 , ≤ 3.32 , or ≤ 2.5 respectively.

Further evidence that granulite facies fluid infiltration has not been important at Cascade Slide comes from oxygen isotopes (Valley and O'Neil 1984; Valley 1985). Any fluids (H_2O or CO_2) passing through the xenolith would first have passed through the surrounding anorthosite ($\delta^{18}\text{O}=9.7$). Subsequent exchange with the calcsilicates ($\delta^{18}\text{O}=17.6$ to 26.1) would tend to homogenize this large premetamorphic difference with the result that $\delta^{18}\text{O}$ in the xenolith would be reduced. The highest values of $\delta^{18}\text{O}$ (26.1) in monticellite marble are thus very restrictive to theories of fluid infiltration and require fluid/rock < 0.1 .

Three lines of evidence argue against the presence of fluid during the granulite facies metamorphism at Cascade Slide: 1) Assemblages of monticellite + forsterite + diopside + calcite + spinel plot in the fluid-absent field, including that if a fluid had existed, $\text{PH}_2\text{O} + \text{PCO}_2 \leq 0.4$ kbar. 2) The large gradients in buffered values of $f\text{CO}_2$ across the body and the fragile nature of the buffering assemblages would have been erased by CO_2 infiltration, even by quantities as low as $\text{CO}_2/\text{rock} = 0.001$. 3) The preservation of high $\delta^{18}\text{O}$ in the core of the xenolith and the sharp gradients of up to 18 permil/15 m would all have been homogenized if either H_2O or CO_2 had infiltrated the xenolith in quantities greater than fluid/rock - 0.1. These results are all consistent with the polymetamorphic history proposed by Valley (1985).

Monticellite has also been found at Westin Mines (5 km to the E of Cascade Slide) where magnetite skarn replaces marble at the contact of the anorthosite massif (Valley and Graham, 1991). This locality is on private property and won't be visited. Magnetites from marble at this deposit were the first to be analyzed for oxygen isotope ratio by ion microprobe with accuracy of ± 1 ‰ (1σ). This analysis yields spatial resolution as small as $2\mu\text{m}$ and has reduced sample size by 11 orders of magnitude relative to conventional techniques, permitting new studies of oxygen diffusion, fluid exchange, and Adirondack cooling rate.

Turn left on Rt. 73 towards Lake Placid.

- 7.2 100.7 Olympic Ski Jump. Bear left onto Old Military Road
- 3.7 104.4 Junction with Rt. 86, turn west (right).
- 6.4 110.8 Stop light. Continue on Rt. 86 through the Village of Saranac Lake. Continue north on Rt. 86 past hospital and out of Saranac Lake Village.
- 4.8 115.6 At junction with Rt. 186, Turn west (left) and continue west.
- 1.8 117.4 Junction with McMaster Road. Continue west.
- 2.2 119.6 Junction of Rts. 30 and 186. Turn north (right) on Rt. 30.
- 1.8 121.4 STOP 7 Low roadcuts on east side of road.

STOP 7 East side of Lake Clear. Anorthositic and Related Mafic Rocks.

This stop consists of a series of low, ledge-like outcrops along the northeast side of Rt. 30. The exposure

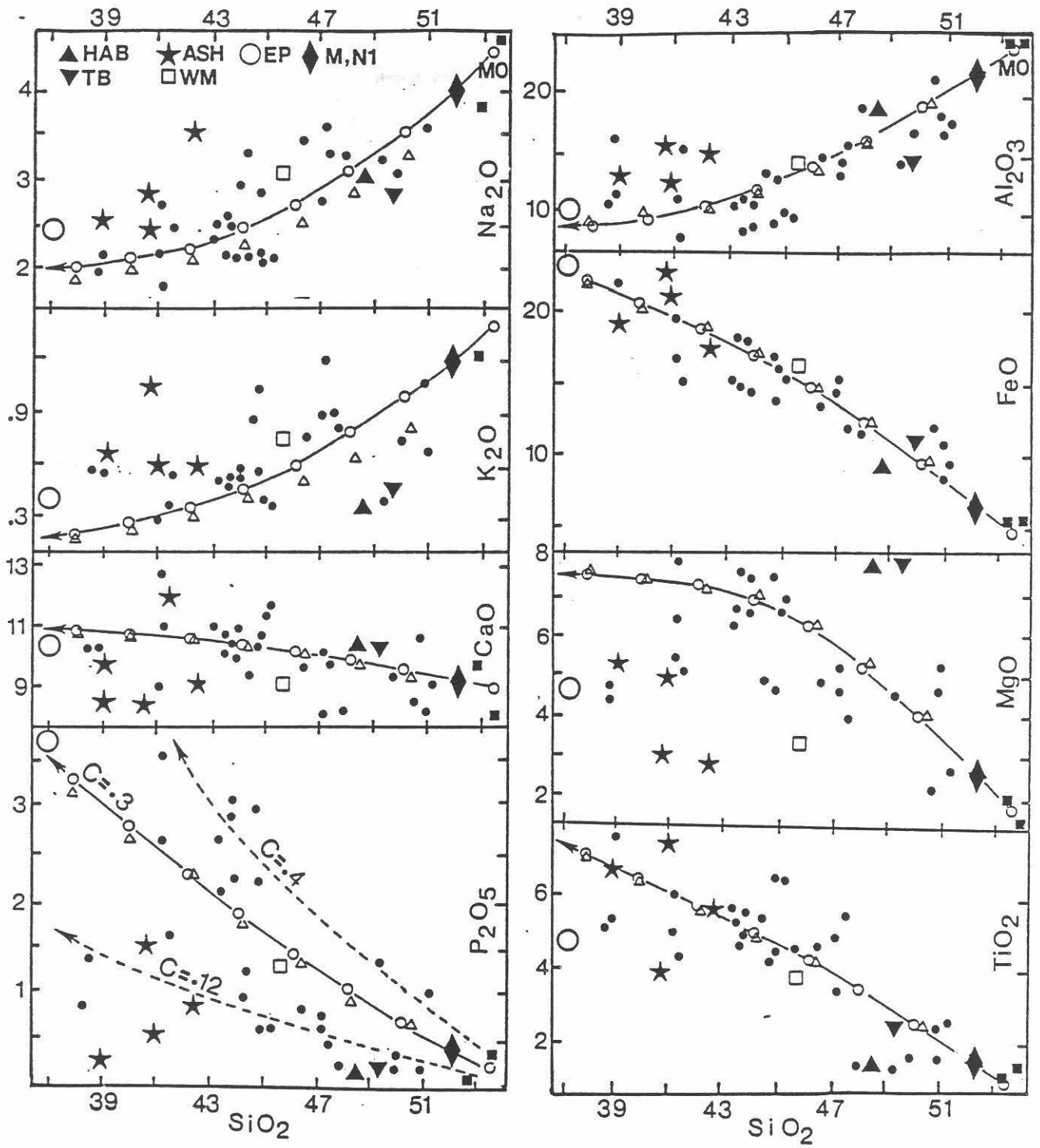

Figure 26 Harker variation diagrams for ferrogabbroic and ferrodioritic dikes and sheets in the Adirondacks. Closed circles are data points from occurrences near Stops 28 and 29. Open square: Woolen Mill gabbro (Stop 34); Stars: Ashwal (1978); HAB: High alumina basalt; TB: Tholeiite basalt. Solid curves are visually smoothed trends through the data. Open circles are compositions taken along solid curve at every 2 wt % SiO₂ (i.e., M0-M8). Open triangles are daughter compositions (N1-N8) calculated by least squares, mass-balance from preceding M-parent. Large open circle represents compositions of glass obtained in melting of Troctolite by Eppler (1987). Dashed curves for Zr are computed by Rayleigh fractionation of an incompatible element with initial concentrations as shown.

provides excellent examples of block structure and crosscutting relationships between a variety of anorthositic facies, including Marcy-type, foliated gabbroic anorthosite, gabbro, and mafic ferrogabbro. Outcrop relationships clearly indicate that the anorthositic rocks have been invaded and disrupted by gabbro and ferrogabbro (Cpx>Opx) which exhibits ophitic to subophitic texture and contains both small plagioclase grains as well as large (up to 10 cm) grains of blue-grey andesine believed to have been plucked from the anorthosite. The mafic content of the gabbro varies from about 25% to 75% and at the mafic-rich end it grades into oxide-bearing ferrogabbro. Blue-grey andesine xenocrysts are common in the ferrogabbros as are Fe, Ti-oxide minerals which cause these rocks to be magnetic. Close inspection suggests that mafic concentrations can commonly be traced back into plagioclase-rich zones where they merge with subophitic interstitial materials suggesting filter pressing.

At the southernmost end of the series of outcrops there is developed block structure of coarse, Marcy anorthosite with blue-grey andesine disrupted by gabbroic and ferrogabbroic material which exhibits "lobate" contacts with the anorthosite, suggesting coeval magmatism. Near the northern end of this outcrop the ferrogabbro becomes exceptionally mafic and includes megacrysts of blue-grey andesine. Narrow, crosscutting veins of sulfide-bearing ferrogabbro are present in the outcrop and some parallel the road along shear zones which are associated with local mylonitization.

To the north, along the series of low outcrops, there is developed more disruption of Marcy-type by gabbroic material which, locally, is the dominant rock type in the outcrop. Commonly, plagioclase laths in the anorthositic rocks exhibit parallel orientation which appears due to magmatic processes and may vary from block to block. Medium grained, light grey leuconoritic xenoliths also occur. Approximately 50 meters from the northern end of the series of outcrops a variety of xenoliths are encountered including a 10 cm long rectangle of green clinopyroxenite. A few feet farther north are several xenoliths of foliated white, fine-grained anorthosite to gabbroic anorthosite. Poorly foliated fine grained, leucocratic anorthosite xenoliths are also present. An exceptionally good example of ferrogabbro-ferrodiorite crosscuts the outcrop here (see sample LKCL4, table 9 for analysis). This and other mafic dikes and sheets in the anorthosite are believed to be the result of filter pressing of interstitial magma from anorthosite rocks at various stages during fractional crystallization.

In the last 50' of the outcrop plagioclase xenoliths and xenocrysts increase as the rocks pass into homogenous, fairly typical Marcy facies with large blue-grey andesine in a finer grained white to grey matrix. Although some of this matrix may be due to crushing, it is believed that most consists of originally finer grained anorthosite intrusive into, and disrupting, the Marcy facies.

Approximately 0.1 mile north along the highway there is exposed a gabbroic anorthosite that disrupts coarser grained anorthosite. A thin (1-2 cm) vein of magnetite-pyroxenite crosscuts, parallel to the road for the length of the outcrop and appears to displace some poorly understood layering in the anorthositic rocks. A green, diopsidic xenolith of calcsilicate is present on the top of the outcrop.

Farther to the north, across a driveway, and opposite a tennis court, there is exposed a long, high roadcut of coarse grained anorthositic gabbro gradational to gabbro with local concentrations of large, blue-grey andesine megacrysts. These rocks, are crosscut by a finer grained, more leucocratic anorthosite that is locally dominant and by a late, pink granitic dike. Several rounded xenoliths of calcsilicate occur in the outcrop.

Among the many valuable relationships to be seen at this stop are the crosscutting phases of the anorthositic series with the oldest, as at Giant Mt., being the coarse Marcy facies. In addition, the existence of fine grained, anorthositic magma is further confirmed. Late gabbro and mafic gabbro are better developed here than at Giant Mt. and the gradation of these rocks to ferrogabbro is well documented on the outcrop. These iron-rich mafic phases represent residual liquids, together with some cumulates, filter pressed during fractional crystallization of anorthositic gabbro. Figure 26 summarizes the trends recorded by these dikes and provides compelling evidence for an Fe-enrichment, Fenner trend in the anorthositic series. The large circles in 36 wt% SiO₂ in figure 26 represent oxide concentrations in an experimental glass produced by Eppler and corroborate the existence of liquids of these extreme compositions, i.e., exceptionally enriched in TiO₂, FeO, and P₂O₅. Mass balance analysis (fig. 27) of these trends (Moore et al. 1992, Denny et al. 1992, Ashwal 1978) demonstrate that plagioclase-dominant fractionation accounts for the indicated trends. It is thought that liquid immiscibility may occur at SiO₂ concentrations somewhat less than 36 wt% to produce magnetite-ilmenite deposits such as those at Tahawus. Chondrite-normalized REE concentrations calculated from the mass balance model correspond almost exactly to observed trends and demonstrate the validity of the model (fig. 28).

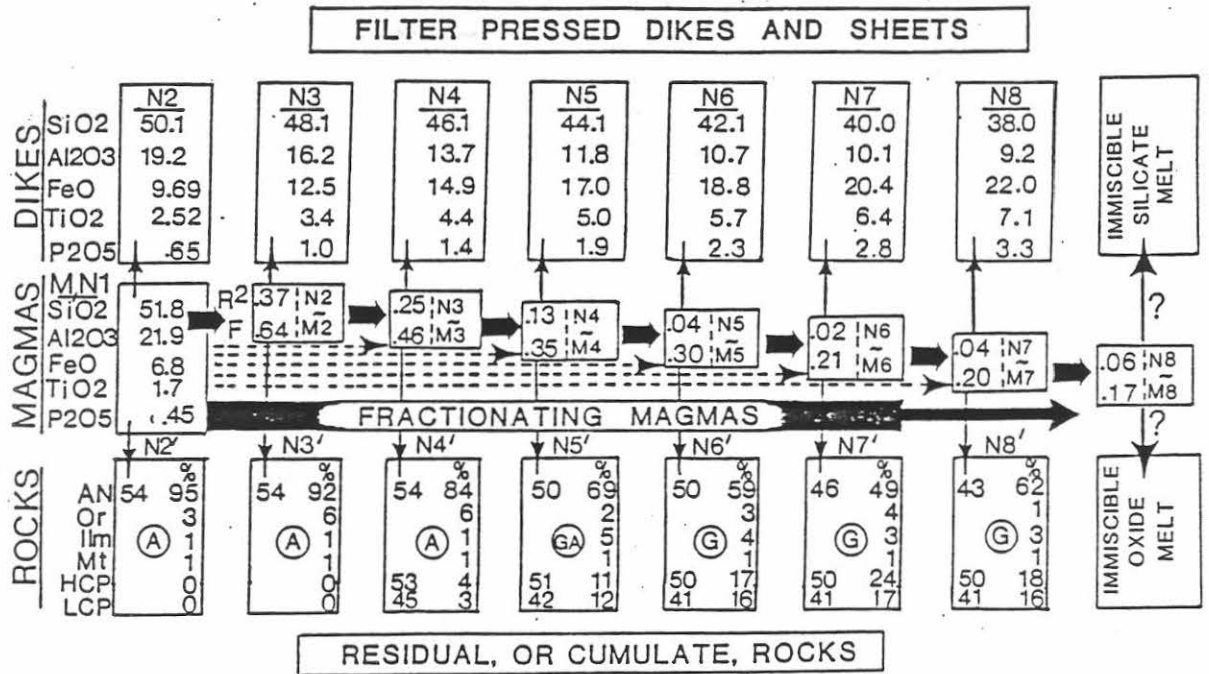

Figure 27 Schematic model of least squares, mass-balance calculations beginning with a Whiteface-type anorthositic gabbro (N1) and filter pressing out N2-N8 mafic magmas as the residual rocks (N1'-N8') of the given mineralogy are left behind. The fraction of liquid (F) and R² values are given. The long dashed arrows represent magmas that have evolved to some composition, say N5 before being filter pressed into N6 and N6'. The short, black arrows assume sequential filter pressing. The residual instantaneous solids become part of the overall rock, which is clearly anorthositic.

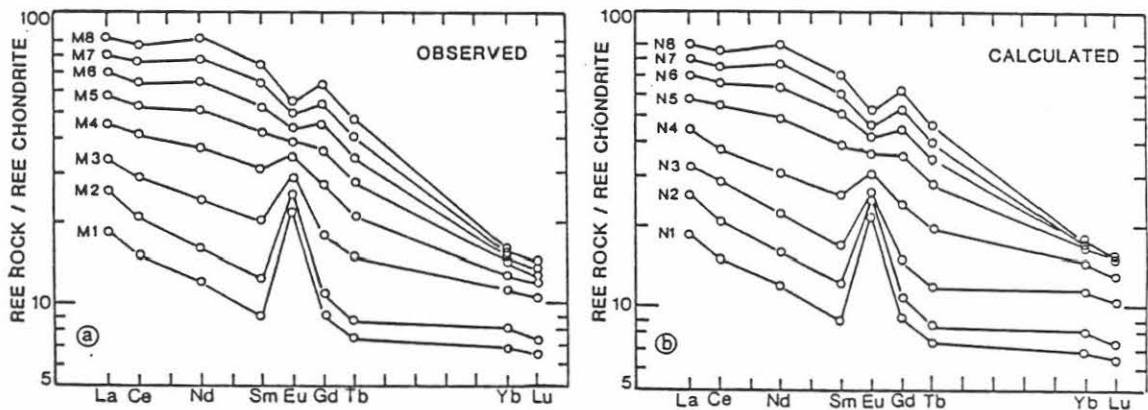

Figure 28 Chondrite normalized REE abundances in (a) observed and (b) calculated differentiates from Whiteface-type (M1, N1) parental magma. Calculated values are based upon the quantity and composition of solids removed in Steps N1-N8 of the mass balance model developed for major elements.

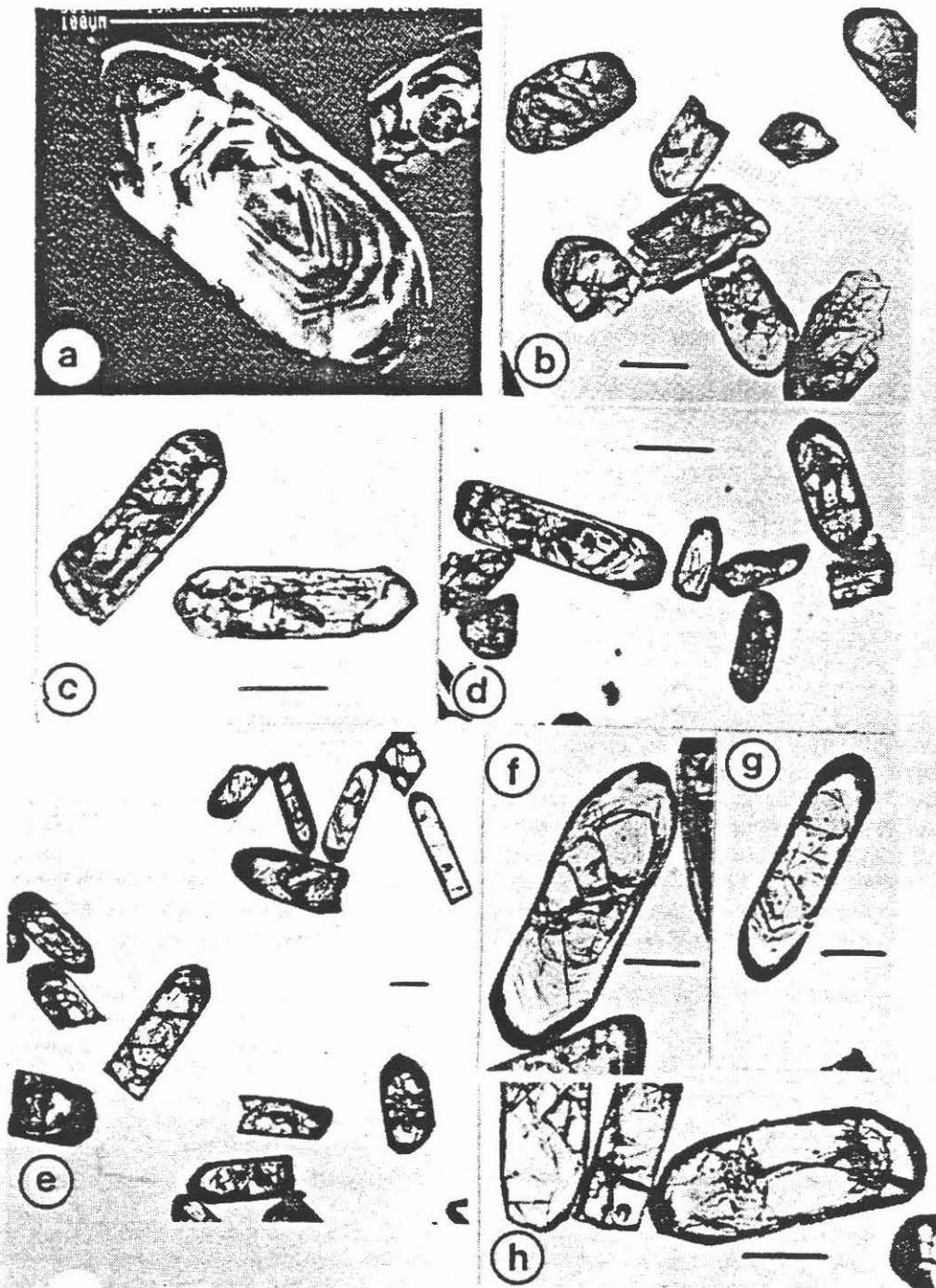

FIG. 29 Photomicrographs and images of zircons from major Adirondack highland granitoid suites. (a) SEM-cathodoluminescence image of *ca.* 1300 Ma zircon from tonalitic gneiss at Canada Lake. Note internal igneous zoning and clear metamorphic overgrowth. The overgrowth has been dated at *ca.* 1226 Ma. (b) Zircon fragments from the 1147 ± 10 Ma Stark complex (AM-86-15). Several of the fragments exhibit fine internal zoning. (c) Elongate, zoned zircons from the 1134 ± 4 Ma Tupper Lake mangerite (AC-85-6). Inclusions, including apatite, are readily visible. Thin metamorphic (?) overgrowths round off well-developed bipyramids. (d) Elongate, zoned, inclusion-bearing zircons from the 1098 ± 4 Ma Tupper Lake granitic gneiss (AM-86-6). Note internal zoning rounded by metamorphic (?) overgrowths. (e-h) Elongate, doubly terminated, well-zoned zircons from the 1073 ± 6 Ma Dannemora leucogranitic gneiss (AM-86-10). Well-developed internal zones are rounded by metamorphic or late magmatic rims.

dark layers. At both the eastern and western extremities of the outcrop they occur facies typical of the least contaminated granite. These consist of pink, medium grained alaskite whose major mafic mineral is magnetite. Small quantities of diopside and sphene are also present, probably due to contamination. The feldspar in these rocks consists almost wholly of mesoperthite or microcline perthite indicating that these are hypersolvus granites.

Initially, McLelland (1986) interpreted these alaskites as metavolcanic members of the 1130–1150 Ma AMCG magmatism. However, U-Pb zircon data acquired from this outcrop, as well as three others in the northern and eastern Highlands, yield well constrained ages of ca. 1060–1080 Ma (table 1). The zircons from these rocks exhibit morphological, zoning, and systematics characteristics that are typical of zircons crystallized from melts (fig. 29) rather than those grown during metamorphism. Therefore, the 1050–1080 Ma ages given by these zircons date the time of crystallization of the zircons, and the alaskite, from a magma. Clearly, this magma could not have been extruded as a volcanic, since an abundance of uncontested evidence dictates that the entire region was undergoing granulite facies (Ottawan) metamorphism at 20–25 km during this time interval. Therefore, the alaskites are best interpreted as synorogenic, hypersolvus granites intruded at considerable depth during the late stages of the Ottawa Orogeny. Placing the intrusive events at the late stages of orogeny helps to explain the highly variable development of strain-related fabrics in these rocks, some of which are devoid of any evidence of strain but do contain good igneous textures. An intrusive origin for the alaskites is also consistent with their hypersolvus feldspars which require temperatures of ~800° C at pressures of 7.5–8 kb and their unusually high Zr-concentrations of up to 2000 ppm, (table 3) which, for rocks of this composition require temperatures of ~1000° C (Watson and Harrison, 1983). Both these constraints require temperatures well above those of regional metamorphism (fig. 13) and preclude a metamorphic origin for these rocks. Finally, note that the alaskitic and related granitic gneisses contain no vestige, or even hint, of any primary volcanic characteristics.

Two major reasons for suggesting a metavolcanic origin for these rocks were 1) the extreme sodic (up to 10–11% Na₂O) or potassic (up to 10% K₂O) concentrations of some members which could be accounted for by alteration at the surface, and 2) the presence of semiconformable interlayers, including low-Ti magnetite deposits. The extreme compositions which are not uncommon in acidic volcanics of the S. W. United States and may be either original or due to metasomatic processes operating during late magmatism. While extrusive examples are most commonly described, intrusive examples of extreme compositions also exist in intrusive suites, and may be either primary or due to metasomatism. Examples of both possibilities are well documented in the literature with the late Himalayan leucogranites being an example of extreme original magmas (Leforte, 1981), and the Wilson Ridge Pluton of Nevada (Smith et al. 1990) serving as an example of metasomatic alteration at depth.

Figure 5a shows the distribution of the 1050–1080 Ma alaskitic gneisses in the northern and eastern Highlands. Whitney and Olmsted (1989) have thoroughly described these rocks and given the name Lyon Mt. Gneiss to the association. From the foregoing presentation, it appears that the Lyon Mt. Gneiss is not part of the AMCG suite.

- 11.3 35.4 Entering Village of Tupper Lake
2.6 Junction Rts. 3 and 30 in Tupper Lake. Run right (south) on Rt. 30 towards Long Lake
3.5 38.8 STOP 9 Mangerite dated at 1134±4 Ma

STOP 9 Long Roadcut of Mangerite

A long roadcut through grey-green mangerite extends for several hundred feet along the south side of the highway. The rock is typical of Adirondack mangerite and consists dominantly of coarse (1–3 cm) grains of mesoperthite (ternary feldspar) together with 5–10% quartz. A chemical analysis is given in table 3 (AC-85-6). Interstitial to the mesoperthite grains are intergrowths of iron-rich clinopyroxene and orthopyroxene which exhibits an elongate habit suggestive of acicular texture. The pyroxenes occur in strained, elongate concentrations that are commonly accompanied by fine-grained plagioclase (AN₂₅₋₃₀). At contacts between the plagioclase and mesoperthite a great deal of myrmekite is developed at the expense of the mesoperthite. In addition, a separate, fine-grained micropegmatitic intergrowth of quartz and perthite are also interstitial to the large grains of mesoperthite. Present in most thin sections are xenocrysts of andesine (AN₄₅) which exhibit characteristic magnetite-ilmenite clouding. These grains are strongly zoned outward to AN₂₅₋₃₀. Blue-grey andesine xenocrysts can be seen on the outcrop but are made best visible by straining.

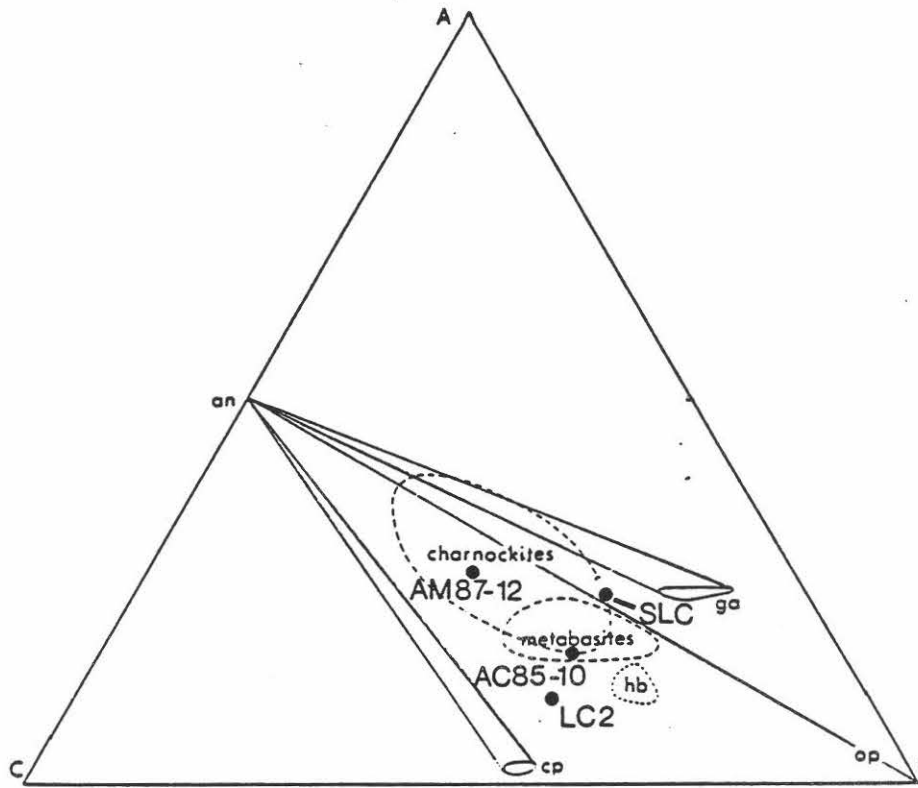

Figure a. ACF diagram for the granulite facies, showing the range of compositions of charnockites and metabasites of the Adirondacks. Garnet appears in part of the charnockites, and disappears in metabasites in the granulite facies. AC 85-10 - Mangerite from south of Tupper Lake, Stop 18, LC-2 - Ferrogabbro from Lake Clear Junction, Stop 28, AM 87-12 - Tonalite from southern adirondacks. SLC - Schroon Lake charnokite (table 3). (After deWaard 1985)

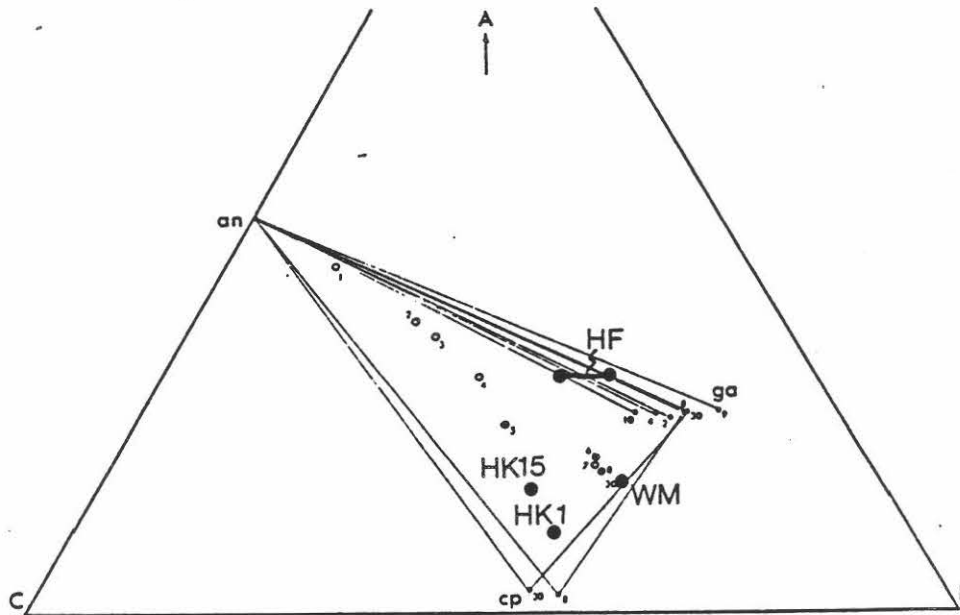

Figure b. ACF diagram illustrating the compositions of predominantly clinopyroxene-bearing garnetiferous granulites (small, numbered points) associated with anorthosite of the Adirondacks. HF - Hulls Falls charnockites, Stop 24; HK 1, 15 - Ferrogabbros from Stop. 29, McMaster Road; WM - Woolen Mill gabbro, Stop 34.

The textures described above record a complicated history for these rocks. It is not known whether the large grains of mesoperthite represent cumulates in the conventional sense, but they were clearly intruded by other magmas subsequent to solidification. At least one batch of this was anorthositic and the other granitic. In the process of some of the hot magma may have experienced supercooling, thus giving rise to acicular orthopyroxenes. Coeval magmatism is also indicated by the fine grained, leucocratic dike at the southern end of the roadcut. This lithology not only crosscuts the mangerite but immediately to the north (left) occurs as an angular xenolith in the mangerite demonstrating contemporaneity. A chemical analysis of the dike yields: SiO₂-67.8, TiO₂-.88, Al₂O₃-16.11, Fe₂O₃-4.65, MgO-.72, CaO-1.23, Na₂O-2.8, K₂O-5.55.

Near its southern termination, the mangerite is crosscut by an irregular dike of green pyroxenite (table 9). This dike, which is similar in some respects to the orthopyroxenite-rich dike at Roaring Brook, consists principally of iron-rich clinopyroxene with a Mg-number of 25, corresponding in composition to clinopyroxene in the mangerite. While the origin of the dike remains uncertain, it is difficult to account for its monomineralic nature in any way but as a mobilized cumulate.

Interestingly, the mangerites at this locality, as well as many others in the region, do not develop garnets, although their mineralogy (feldspar, oxides, pyroxene) and Mg-numbers appear permissive of garnet formation and nearby granitoids are garnetiferous. The reason for the absence of garnet is best explained by differences in bulk chemistry as discussed by deWaard (1965). As shown in fig. 30a sample AC-85-10 from this outcrop plots well below the plagioclase-orthopyroxene join in an ACF project. In contrast, garnetiferous charnockites and mangerites plot above this join. The position where AC-85-10 plots is not determined by Al₂O₃ alone but by the concentration of other oxides as well (note especially the importance of high Na₂O and K₂O in reducing the A-value in the projection). By implication, the mangeritic rocks are within the orthopyroxene-plagioclase subfacies of the granulite facies (deWaard 1964).

Although mangeritic rocks may look simple, they generally are not and, as in this case, commonly exhibit features related to magma commingling. These complicated features, as revealed by microscopic study, and require further investigation.

3.7 42.5 STOP 12 Hornblende granite dated at 1098±6 Ma

STOP 12 Pink Hornblende Granite (1098±4 Ma)

This streaky, pink hornblende granitic is typical of the younger granitic rocks of the Highlands. A chemical analysis is given in table 3 (AM 86-6) and the mineralogy of the rock is dominated by mesoperthite and quartz with only a few small grains of sodic plagioclase and <5% hornblende. Buddington and Leonard (1962) mapped this body of granite as younger than, and crosscutting, the mangerites and quartz-mangerites of the AMCG suite. This field-based interpretation is consistent with geochronology, and the intrusive contact passes through the sand and water covered valley between this stop and the next outcrop due north along Rt. 30.

Figure 5b shows the distribution of the younger granitic rocks whose ages fall into the 1090-1100 Ma range. Within the area shown on fig. 5b, several occurrences of these rocks have been recognized but they do not represent a significant percentage of the designated area. These rocks are enigmatic, since they do not fit into any major chronological or petrologic group. At present, the sample base for this group is too limited to draw major conclusions on their origin, and additional study is required.

1.1 44.6 STOP 13 Large roadcuts of calcsilicate and granite. South end of Tupper Lake

STOP 13 Large Roadcuts of Calcsilicate and Granite, South End of Tupper Lake

High steep roadcuts across from the parking area expose green, foliated diopside-rich calcsilicates containing layers of white, coarse grained pegmatite. Towards the north end of the cut the volume of granite increases until it becomes the dominant phase. On top of the northern portion of the outcrop a variety of disrupted, disharmonic features may be observed in magmatite and attest to the intrusive nature of the granite.

The highly strained calcsilicates are isoclinally folded together with the pegmatitic quartz-feldspar interlayers. However, near road level, in the middle of the outcrop, a shallow-dipping vein of pegmatite, cuts

across foliation and is not folded. This layer is continuous with a steeply dipping, isoclinally folded layer. The only self consistent explanation of this relationship is that the emplacement of granitic material took place syntectonically and outlasted folding.

At the far southern end of the roadcut contaminated, garnetiferous granite has disrupted and incorporated xenoliths of amphibolite. It is common for Adirondack granites to become garnetiferous towards their contacts with biotitic, amphibolitic country rocks, and good examples of this can be found throughout the region. In these instances, the garnets tend to poikilolitically enclose quartz and/or feldspar.

- 9.4 54.0 Entrance to Whitney Park. Intrusive complex of jotunite, anorthosite, and calcsilicates on east side of highway.
- 5.2 59.2 Junction of Rts. 30 and 28N in Long Lake; proceed east on Rt. 28N.
- 17.1 76.3 Scenic overlook at Newcomb picnic area.
- 1.6 77.9 Turn left off of Rt. 28N onto Blue Ridge Highway (a.k.a. Boreas Road).
- 1.2 79.1 Turn north onto road for the Calamity Brook.
- 2.8 82 STOP 14. Gated road to Cheney Pond. Large boulders on either side of road.

STOP 14 Magnetite-Ilmenite Ores at Sanford Lake

According to Stephenson (1945) the Sanford Lake magnetite-ilmenite ores were discovered in 1826 when a party, entering from Indian Pass, encountered the , now mined-out "Iron Dam" of ore which extended across the Hudson River at the present site of the Tahawus Club. Mining began in the 1830's and by the 1840's was supplying ore for the first cast-steel plant in America (Adirondack Iron and Steel Company, Jersey City, N.J.). Production halted in 1858; was reorganized as the MacIntyre Iron Co. in 1894; and resumed production in 1906. Despite extensive planning, little ore was produced or shipped. In 1908 a French metallurgist, A. Rossi, employed by the MacIntyre Iron Co., discovered the suitability of titanium as a white paint pigment. Continued transportation difficulties plagued mining operations until 1941 when N.L. Industries, Titanium Division, acquired the property. By 1942 ilmenite concentrates were being shipped. The mine was extensively developed during, and after, World War II where it was exploited for titanium, and a railroad was built to North Creek. Since approximately 1980, mining activity has slowed, and at present a skeleton crew works the deposits for a variety of purposes. The main pit is flooded, and water level is rising rapidly.

The ore in the Sanford Lake district consists of titaniferous magnetite and hemo-ilmenite in subequal amounts with ilmenite generally being slightly more abundant. Lamellae of ilmenite in magnetite originated via subsolidus oxidation-exsolution (Haggerty 1976). Green pleonaste spinel commonly forms as an exsolution product in magnetite. Iron sulfides occur as accessory phases. Both titanomagnetite and hemo-ilmenite form abundant small, rod-like inclusions in associated plagioclase sometimes rendering them black and opaque. The average composition of titanomagnetite and hemo-ilmenite in the principal ore deposits is given by Kelly (1979) as $Mt_{81}Usp_{18}$ and $Ilm_{94}Hm_6$ respectively.

The ore in the Sanford Lake district occurs in two major modes: 1) as lean or disseminated ore gabbro, and 2) as massive, rich ore generally in anorthosite but locally within gabbro. As pointed out by all students of these deposits, the lean ore within gabbro is gradational into the host rock (with which it is commonly conformably layered, Ashwal 1978, p. 106) but in anorthosite the ore exhibits sharp contacts relative to host rock. Note that ore-bearing gabbro also sharply crosscuts the anorthosite. The massive ore exhibits sharp contacts with host anorthosite and with disseminated ore in anorthosite. With the exception of apatite-rich, and possibly nelsonitic, rocks near Cheney Pond (Kolker), the concentrations of P_2O_5 in the ore deposits is strikingly low. Whole rock chemical analyses are given below.

TABLE 10

	Tahawus Olivine Metagabbro	Sanford Lake Gabbro ¹	Lincoln Pond Gabbro ²	Westport Mafic Gabbro ²	Woolen Mill Gabbro ²	Sanford Lake Ore ¹
SiO ₂	47.62	39.04	44.7	47.88	45.59	4.59
TiO ₂	0.82	6.78	5.26	1.20	3.49	18.58
Al ₂ O ₃	18.69	13.09	12.46	18.90	14.23	5.48
Fe ₂ O ₃	11.40	19.09	4.63	1.39	18.42	nd
FeO	nd	nd	12.99	10.45	nd	66.37
MnO	0.14	.24	.17	.16	.27	.28
MgO	8.85	5.31	10.20	7.10	3.07	3.39
CaO	8.29	9.77	5.34	8.36	9.25	.31
Na ₂ O	2.76	2.02	2.47	2.75	2.63	.22
K ₂ O	0.41	.66	.95	.81	.79	.09
P ₂ O ₅	0.12	.23	.28	.20	1.26	.01
V ₂ O ₅	nd	nd	nd	nd	nd	.45
H ₂ O	—	.03	.64	.61	.70	.10
Total	99.50	96.26	100.09	100.02	100.14	100.06

1) Kelly, 1979; 2) Kemp, 1910

Strip mining and diamond drilling have confirmed that the ore tends to be concentrated in lenses measuring 600–700 m in length and 150–300 m in width. It is not known whether this conformable configuration is the result of crystal settling, intrusion, or the accumulation of immiscible oxide-rich liquids. This uncertainty extends to the petrologic details of the origin of the deposits, although the evolution of these rocks is understood in the broad perspective. As seen at Stops 7 and 8, Day 1, the late differentiates of the anorthosite move toward pronounced enrichment in Fe, Ti-oxides thus yielding liquids of increasingly ferrogabbroic Composition together with associated ultramafic cumulates. As seen in table 10, the gabbro at Sanford Lake, and other occurrences of magnetite-ilmenite ore, is not unlike the Woolen Mill gabbro, which is representative of late anorthositic differentiates. Except for P₂O₅ the Sanford Lake gabbro is also similar to Buddington's (1953) mafic gabbro from McCauley Mt.. Comparisons of this sort suggest that the ores at Sanford Lake are the result of progressive differentiation of magmas residual from gabbroic anorthosite and that, at some point, these magmas became so enriched in iron and titanium that they either precipitate magnetite-ilmenite cumulates (Ashwal 1978) or immiscibility of Fe-Ti oxide and silicate melts occurs (cf. Stephenson 1945; Kelly 1979). In the former case the conformable layers represent cumulate beds and in crosscutting ore horizons represent mobilized cumulates. In the latter case, both layered and crosscutting configurations can be explained on the basis of an immiscible Fe-Ti oxide liquid. A third possibility exists which is a combination of the foregoing alternatives, i.e., magnetite-ilmenite could begin to precipitate relatively early in the history of the complex but continued fractionation might still result in liquid immiscibility at a later stage.

Arguments against liquid immiscibility at Sanford Lake have commonly focused on the low concentrations of apatite in these rocks (note, however, the exception of nelsonite at Cheney Pond). However, as pointed out by Lindsley (1992) P₂O₅ and apatite do not necessarily travel with the immiscible oxide melt. Moreover, P₂O₅ may not be a direct cause of liquid immiscibility but, rather, may play an indirect role in keeping the magma molten until Fe-Ti-O networks in the melt can no longer coexist with the silicate networks and immiscibility occurs. Because of this late magmatic association, apatite and immiscibility would appear to be more directly connected than may actually be the case.

The stop at Sanford Lake takes advantage of excellent relationships exhibited in boulders on either side of the Calamity Brook Road at the gated entrance to the Cheney Pond Road. Over three dozen large, fresh boulders from the mines provide outstanding exposure of anorthosite, gabbro, ore-bearing gabbro, and massive ore crosscutting anorthosite. Several boulders containing both anorthosite and ore exhibit what appear to be coeval and pillowing relationships between the two phases. In other instances massive ore and ore-bearing gabbro crosscut anorthosite. A number of boulders show irregular oxide-rich veins, some of which clearly contain separate fractions of oxide and silicate suggestive of liquid immiscibility. Many of the ore boulders contain xenoliths and enclaves of anorthosite and xenocrysts of andesine some of which are black due to oxide inclusions. Several boulders of good Marcy-type anorthosite are present as are some sheared, hornblende-bearing gabbroic anorthosite.

Relationships seen in these boulders demonstrate that the Fe, Ti-oxide ore derives from the gabbros and bears intrusive relationships to the anorthosite. Polished slabs show the oxide phase to intimately penetrate and disrupt the anorthosite on a scale smaller than the grain size of magnetite and ilmenite in adjoining ore. This suggests that the oxide intruded as a liquid and this observation, together with evidence of liquid immiscibility in similar rocks (Lindsley 1992), lead us to suggest that most, if not all, of the Sanford Lake ores were emplaced as immiscible liquids.

Turn around and return to intersection.

- | | | |
|-----|------|--|
| 2.8 | 84.8 | Turn south on main road (side trip to visitors overlook at open pit mine). |
| 6.4 | 91.2 | Intersection with Blue Ridge Highway; turn east (left). |
| 1.5 | 92.7 | STOP 15. Olivine metagabbro. |

STOP 15 Olivine Metagabbro in Roadcuts on Blue Ridge Highway

Steep roadcuts on either side of the highway expose good examples of Adirondack olivine metagabbro. The rock consists of round, ~.25 cm coronas of red biotite and brown hornblende coronas on oxides set in a garnetiferous matrix of green, spinel-clouded plagioclase and subophitic pyroxenes. Olivine is not abundant in this outcrop although it is widespread throughout most of this relatively large body. A whole rock analysis given in table 10 (olivine-metagabbro-Tahawus).

There are a large variety of olivine metagabbros in the Adirondacks ranging from Mg-rich to Fe-rich. These are exposed throughout the region but are especially abundant in proximity to bodies of anorthosite. As seen in fig. 2, the southern and eastern margins of the Marcy massif are especially rich in olivine metagabbro. McLelland (1986) has suggested that these bodies are representative of the magmas ponded at the crust-mantle interface that gave rise to the parental magmas of the anorthosite. The bodies not exposed at the surface are interpreted to be late plutons that ascended, without ponding, after the major mass of AMCG had risen and provided crustal pathways. This suggestion is consistent with geochronological data indicating that the gabbros are contemporaneous with the AMCG suite (table 1, samples 21, 22). Given the possibility of this scenario, further detailed petrological studies of the olivine metagabbro should be undertaken.

Coronas developed in olivine metagabbros have been of petrologic interest for over 100 years. McLelland and P.R. Whitney of the New York State Geological Survey investigated these features in the 1970s and 1980s and references are cited in the bibliography.

END OF DAY 2 - END OF FIELD TRIP

REFERENCES CITED

- Alling, H.L., 1917, The Adirondack Graphite Deposits: N.Y. State Mus. Bull. 199, 150 p.
- _____, 1927, Stratigraphy of the Grenville of the eastern Adirondacks: Geol. Soc. Amer. Bull., 38, p. 795-804.
- Ambers, C.P., and Hudson, M.R., 1985, Syntectonic metamorphism in the Halesboro fault zone, Northwest Adirondacks: Geol. Soc. Amer. Abs. with Prog., v. 17, p. 2.
- Anderson, J.L., 1983, Proterozoic anorogenic granite plutonism of North America, in Medaris, L.; Byers, C.; Mickelson, D.; and Shanks, W., eds., Proterozoic Geology: Selected Papers from an International Symposium: Geol. Soc. America Spec. Paper 161, p. 133-154.
- Ashwal, L.D., 1978, Petrogenesis of massif-type anorthosites: Crystallization history and liquid line of descent of the Adirondack and Morin complexes: Ph.D. Thesis, Princeton U., 136 p.
- _____, and Seifert, K.E., 1980, Rare earth element geochemistry of anorthosite and related rocks from the Adirondacks, New York and other massif-type complexes: Geol. Soc. Amer. Bull., Pt. II, v. 91, p. 659-684.
- _____, and Wooden, Jr., 1983, Sr and Nd isotope geochronology, geologic history, and origin of Adirondack anorthosite: Geochim. Cosmochim. Acta, v. 47, p. 1875-1887.
- Baillieu, T.A., 1976, The Cascade Slide: A mineralogical investigation of a calcisilicate body on Cascade Mountain, New York: M.S. Thesis, Univ. of Massachusetts, Amherst.
- Barker, F., 1979, Trondhjemite: definition, environment, and hypothesis of origin, in Barker, F., ed., Trondhjemites, dacites, and related rocks: Elsevier, New York, p. 1-12.
- Bartholome, P.M., 1956, Structural and petrological studies in Hamilton County, New York: Ph.D. Thesis, Princeton Univ., 118 p.
- Basu, A.R., and Pettingill, H.S., 1983, Origin and age of Adirondack anorthosites re-evaluated with Nd isotopes: Geology, v. 11, p. 514-518.
- Beddoe, T.A., 1981, Anorthositic sills of the southern Adirondack Mountains: Ph.D. Thesis, Virginia Polytechnic Inst., 250 p.
- Bohlen, S.R., 1987, Pressure-temperature-time paths and a tectonic model for the evolution of granulites: Jour. Geology, v. 95, p. 617-632.
- _____, and Boettcher, A.L., 1981, Experimental investigations and geological applications of orthopyroxene geobarometry, Amer. Mineral., v. 66, p. 951-964.
- _____, and Essene, E., 1977, Feldspar and oxide thermometry of granulites in the Adirondack highlands: Contrib. Mineral. Petrol., v. 62, p. 153-169.
- _____, and _____, 1977, Feldspar and oxide thermometry of granulite in the Adirondack Highlands: Contrib. Mineral. Petrol., v. 62, p. 153-169.
- _____, and _____, 1978, Igneous pyroxenes from metamorphosed anorthosite massifs: Contrib. Mineral. Petrol., v. 65, p. 433-442.
- _____, and _____, 1979, A critical evaluation of two-pyroxene thermometry in Adirondack granulites: Lithos, v. 12, p. 335-345.
- _____, Valley, J., and Essene, E., 1985, Metamorphism in the Adirondacks. I. Petrology, pressure, and temperature: Jour. Petrology, v. 26, p. 971-992.
- _____, and Wall, V.J., and Boettcher, A.L., 1983a, Experimental investigation and application of garnet granulite equilibria: Contrib. Mineral. Petrol., v. 83, p. 52-61.
- _____, _____, and _____, 1983b, Experimental investigations and geological applications of equilibria in the system FeO-TiO₂-Al₂O₃-SiO₂-H₂O: Amer. Mineral., v. 68, p. 1049-1058.
- Boone, G.M., 1978, Kyanite in Adirondack highlands sillimanite-rich gneiss, and P-T estimates of metamorphism: Geol. Soc. Amer. Abs. with Prog., v. 10, p. 34.
- Brown, C., 1982, Calcalkaline intrusive rocks: Their diversity, evolution, and relation to volcanic arcs, in Thorpe, R., ed., Andesites-orogenic andesites and related rocks: John Wiley and Sons, NY, p. 437-461.
- Brown, C.E., 1973, Northeast trending faults in Grenville series, New York: U.S. Geol. Surv. Prof. Paper 850, p. 35-36.
- _____, 1980, Lineated granitic rocks mark early faults in the Beaver Creek area, St. Lawrence Co., New York: U.S. Geol. Surv. Prof. Paper 1175, p. 6-7.
- _____, 1983, Mineralization, mining, and mineral resources in the Beaver Creek area of the Grenville lowlands in St. Lawrence County, New York: U.S. Geol. Survey Prof. Paper 1279, 21 p.
- _____, 1988, Geologic map of the Birch Creek area, St. Lawrence Co., New York: U.S. Geol. Surv. Misc. Inv. Map, I-1645.
- _____, and Ayuso, R.A., 1985, Significance of tourmaline-rich rocks in the Grenville complex of St. Lawrence County, New York: U.S. Geol. Survey Bull. 1626-C, 35 p.
- Brown, L.; Ando, C.; Klemperer, S.; Oliver, J.; Kaufman, S.; Czuchra, B.; Walsh, T.; and Isachsen, Y.W., 1983, Adirondack-Appalachian crustal structure: the COCORP northeast traverse: Geol. Soc. Amer. Bull. 94, p. 1173-1184.
- Brown, P.E.; Essene, E.J.; and Kelley, W.C., 1978, Sphalerite geobarometry in the Balmat-Edwards district, New York: Amer. Mineralogist, 63, p. 250-257.
- Brown, J.S., and Engel, A.E.J., 1956, Revision of Grenville stratigraphy and structure in the Balmat-Edwards area, northwest Adirondacks, New York: Geol. Soc. Amer. Bull. 67, p. 1599-1622.
- Buddington, A.F., 1929, Granite phacoliths and their contact zones in the northwest Adirondacks, New York: New York State Museum Bull., 281, p. 51-107.
- _____, 1939, Adirondack igneous rocks and their metamorphism: Geological Society of America Memoir 7, 354 p.
- _____, 1963, Metasomatic origin of a large part of the Adirondack phacoliths: a discussion: Geol. Soc. Amer. Bull., 74, p. 353.
- _____, 1969, Adirondack anorthosite series, in Origin of anorthosite and related rocks, Isachsen, Y.W. (ed): New York State Museum Mem. 18, p. 215-232.
- _____, 1972, Differentiation trends and parent magmas for anorthosite and quartz mangerite series, in Shagam, R., et al., eds., Studies in earth and space sciences: Geol. Soc. America Spec. Paper 18, p. 215-232.
- _____, 1977, Guidebook for field trips, petrology and mineral deposits, northwestern and northern Adirondack area: (Unpublished), 104 p.
- _____, and Leonard, B., 1962, Regional geology of the St. Lawrence County magnetite district, northwest Adirondacks, New York: U.S. Geol. Surv. Prof. Paper 376, 145 p.
- _____, and Whitcomb, L., 1941, Geology of the Willisboro Quadrangle, New York: New York State Museum Bull., 325, p. 137.
- Burchfiel, B.C., and Royden, L., 1985, North-south extension within the convergent Himalaya region, Geology, v. 13, p. 679-682.
- Carl, J.D., 1981, Alkali metasomatism in the Major Gneiss, northwest Adirondacks, New York: Open system or closed?: Geochim. et Cosmochim. Acta, 45, p. 1603-1707.
- _____, 1988, Popple Hill gneiss as dacite volcanics: A geochemical study of mesosome and leucosome, northwest Adirondacks, New York: Geol. Soc. Amer. Bull. (in press).
- _____, deLorraine, W.; Mose, D.; and Shieh, Y., 1990, Geochemical evidence for a revised Precambrian sequence in the northwest Adirondacks, New York: Geol. Soc. America Bull., v. 102, p. 182-192.
- _____, and VanDiver, B.B., 1971, Some aspects of Grenville geology and the Precambrian/Paleozoic unconformity, northwest Adirondacks, New York: N.Y. State Geo. Assn. Guidebook, 43rd Ann. Mtg., Potsdam, p. A1-A39.
- Cartwright, I., and Valley, J.W., 1988, Retrograde fluids and shearing in the Diana and Stark Complexes: Stable isotope and petrologic considerations: EOS, Trans. Am. Geophys. Un., 69, p. 508.
- _____, and _____, 1991, Steep oxygen isotope gradients at marble-metagranite contacts in the NW Adirondack Mts., NY, Earth. Planet. Sci. Letters, 107, p. 148-163.
- _____, _____, and Hazelwood, A.M., 1992, Extent and causes of resetting of oxybarometers and oxygen isotope ratios in granulite facies orthogneiss, Adirondack Mts., N.Y.: Contrib. Min. Petrol. (in review).
- Chiarenzelli, J.; Bickford, M.E.; McLelland, J.M.; Isachsen, Y.W.; and Whitney, P.R., 1987, Early igneous history of the Adirondack Mountains as revealed by U/Pb ages: Geol. Soc. Amer. Abstracts with Programs, 19, p. 619.
- Chiarenzelli, J., and McLelland, J., 1991, Age, chemistry, and regional relationships of granitoid rocks of the Adirondack highlands, Jour. Geology, v. 99, p. 571-590.
- Connerney, J.; Nekt, T.; and Kuckes, A., 1980, Deep crustal electrical conductivity in the Adirondacks: J. Geophys. Res., 85, p. 2603-2614.
- Cox, K.G., 1980, A model for flood basalt volcanism: Jour. Petrol., v. 21, p. 629-650.
- Culotta, R.; Pratt, T.; and Oliver, J., 1990, A tale of two sutures: COCORP's deep seismic surveys of the Grenville province in the eastern U.S. midcontinent: Geology, v. 18, p. 646-649.
- Cushing, H.P.; Fairchild, H.L.; Ruedemann, R.; and Smyth, C.H. Jr., 1910, Geology of the Thousand Islands region: New York State Museum Bull. 145, 194 p.
- Daly, J.S., and McLelland, J., 1991, Juvenile Middle Proterozoic crust in the Adirondack highlands, Grenville Province, northeastern North America, Geology, v. 19, p. 119-122.
- Davidson, A., 1984, Identification of ductile shear zones in the southwestern Grenville Province, in Kroner, A., and Greiling, R., eds., Precambrian Tectonics Illustrated: E. Schweiz. Verlagsbuch., Stuttgart, p. 263-279.
- _____, Culshaw, N.G.; and Nadeau, L., 1982, A tectono-metamorphic framework for part of the Grenville Province, Parry Sound Region, Ontario: Current Research, Part A., Geological Survey of Canada Paper 82-1A, p. 175-190.
- Davis, B.T.C., 1969, Anorthositic and quartz syenitic series of the St. Regis quadrangle, New York, in Origin of Anorthosite and related rocks, Isachsen, Y.W. (ed): New York State Museum Memoir 18, p. 281-288.
- deLorraine, W.F., 1979, Geology of the Fowler ore body, Balmat #4 Mine, Northwest Adirondacks, N.Y.: MS Thesis, Univ. of Mass., Amherst, 159 p.
- _____, and Carl, J.D., 1986, Guidebook for field trips: Precambrian stratigraphy of the northwest Adirondacks, New York: Friends of the Grenville.
- _____, and _____, 1988, Precambrian stratigraphy in the northwest Adirondacks, New York: The Thousand Islands and Frontenac Axis: Geol.

- Soc. Amer. Abstracts with Programs, 20, p. 14.
- _____, and Dill, D.B., 1982, Structure, stratigraphic controls, and the genesis of the Balmat zinc deposits, northwest Adirondacks, New York, in: *Precambrian Sulphide Deposits*, Hutchinson, R.W.; Spence, C.D.I.; and Franklin, J.M. (eds): Geol. Soc. Canada Special Paper 25, p. 571-596.
- DePaolo, D., 1981, Neodymium isotopes in the Colorado Front Range and crust-mantle evolution in the Proterozoic, *Nature*, v. 291, p. 193-196.
- deWaard, D., 1964, Structural analysis of a Precambrian fold: the Little Moose Mt. syncline, SW Adirondacks: *Koninkl. Nederl. Akad. Van Wetenschappen, Ser. B.*, v. 65, p. 404-417.
- _____, 1965, The occurrence of garnet in the granulite-facies terrane of the Adirondack Highlands: *Jour. Petrology*, v. 6, p. 165-191.
- _____, 1969, Facies series and P-T conditions of metamorphism in the Adirondack Mountains: *Proc. Kon. Akad. Wetensch.* 50, p. 124-131.
- _____, 1970, The anorthosite-charnockite suite of rocks of Roaring Brook Valley in the eastern Adirondacks (Marcy Massif): *Amer. Mineral.*, 55, p. 2063-2075.
- Dewey, J.F., and Burke, K.C.A., 1973, Tibetan, Variscan and Precambrian basement reactivation: products of continental collision: *J. Geol.*, 81, p. 683-692.
- Dunn, S.R., and Valley, J.W., 1992, Calcite-graphite isotope thermometry: a test for polymetamorphism in marble, Tudor gabbro aureole, Ontario, Canada: *J. Meta. Geol.* 10 (in press).
- Eiler, J.M., 1991, Oxygen isotope studies of Adirondack orthogneiss, MS thesis, University of Wisconsin-Madison.
- _____; Baumgartner, L.P.; and Valley, J.W., 1992, Intercrystalline stable isotope diffusion: A fast grain boundary model: *Contrib. Min. Petrol.* (in review).
- _____, and Valley, J.W., 1990, Oxygen isotope evidence for the evolution of Adirondack granulites related to anorthosite: *Geol. Soc. Am. Abs. with Programs*, v. 22, p. A301.
- _____, and _____, 1991, Stable isotopic characteristics and magmatic history of meta-igneous rocks, Adirondacks, NY: EOS, 72, p. 310.
- Ellis, D.J., and Green, D.H., 1979, An experimental study of the effect of Ca upon garnet-clinopyroxene Fe-Mg exchange equilibria: *Contrib. Mineral. Petrol.*, 71, p. 13-22.
- Emery, J.A., 1968, Geology of the Pea Ridge iron ore body, in: *Ore Deposits in the United States, 1933-1967*, Vol. 1, The Graton-Sales Volume, Ridge, J.D. (ed), p. 358-369.
- Emmons, E., 1842, Geology of New York. Part II, comprising the survey of the second geological district, Albany, NY.
- Emslie, R.F., 1978, Anorthosite massifs, rapakivi granites, and late Precambrian shifting of North America: *Precambrian Research*, 7, p. 61-98.
- _____, 1985, Proterozoic anorthosite massifs, in: *The deep Proterozoic crust in the North Atlantic provinces*, Tobi, A.C., and Touret, J.L.R. (eds): Reidel, p. 39-60.
- _____, and Hunt, P., 1990, Ages and petrogenetic significance of igneous mangerite-charnockite suites associated with massif anorthosites, Grenville province: *Jour. Geol.*, v. 98, p. 213-231.
- Engel, A., and Engel, C., 1958, Progressive metamorphism and granitization of the Major Paragneiss, Northwest Adirondack Mountains, New York: *Geol. Soc. America Bull.*, v. 69, p. 1369-1414.
- _____, and _____, 1963, Metasomatic origin of large parts of the Adirondack phacoliths: *Geol. Soc. Amer. Bull.*, 74, p. 349-354.
- Epler, N., 1987, Experimental study of Fe-Ti oxide ores from the Sybille Pit in the Laramie Anorthosite, Wyoming: MSc. Thesis, SUNY, Stony Brook, 66 p.
- Foose, M.P., 1974, The structure, stratigraphy, and metamorphic history of the Bigelow area, northwest Adirondacks, New York: Ph.D. Thesis, Princeton Univ., Princeton, NJ, 224 p.
- _____, and Carl, J.D., 1977, Setting of alaskite bodies in the northwest Adirondacks: *Geology*, 5, p. 77-80.
- Fram, M., and Longhi, J., 1991, Experimental petrology of massif anorthosites: IGCP-290 Abstracts, Colgate Univ., Hamilton, NY, p. 4.
- Fyfe, W.S.; Price, N.J.; and Thompson, A.B., 1978, Fluids in the Earth's Crust: Elsevier, 383 p.
- Gallagher, D., 1937, Origin of the magnetite deposits at Lyon Mountain, New York: *New York State Museum Bull.*, 311, 85 p.
- Geraghty, E.P., and Isachsen, Y.W., 1981, Investigation of the McGregor-Saratoga-Ballston Lake fault system, east central New York: U.S. Nuclear Regulatory Comm. Report NUREG/CR-1866, 44 p.
- Gerdes, M.L., 1991, A petrographic and stable isotopic study of fluid flow and mass transport at the Valentine Wollastonite Mine, NW Adirondack Mts., NY, MS thesis, University of Wisconsin-Madison.
- _____, and Valley, J.W., 1990, Fluid-rock interaction at the Valentine Wollastonite Mine, NW Adirondack Mountains, NY: Multiple episodes of channelized fluid infiltration: *Geol. Soc. Am. Abs. with Programs*, v. 22, p. A212.
- _____, and _____, 1992, The Valentine Wollastonite Mine, NY: *Geol. Soc. Am. Sp. Paper* (in submission).
- _____, _____, and Baumgartner, L.P., 1991, Fluid evolution and mass transport at the Valentine Wollastonite Mine, Adirondack Mountains, NY: *Geol. Soc. Am. Abs. with Programs*, v. 23, no. 5, p. 334.
- Goldsmith, J.R., and Newton, R.C., 1969, P-T-X relations in the system CaCO₃-MgCO₃ at high temperatures and pressures: *Am. Jour. Sci.*, 267-A, p. 160-190.
- Grant, N.K.; Carl, J.D.; Lepak, R.J.; and Hickman, M.H., 1984, A 350 Ma crustal history in the Adirondack lowlands: *Geol. Soc. Amer. Abstracts with Programs*, 16, p. 19.
- _____; Lepak, R.; Maher, T.; Hudson, M.; and Carl, J., 1986, Geochronological framework of the Grenville Province of the Adirondack Mountains: *Geol. Soc. America Abs. with Prog.*, v. 18, p. 620.
- Grauch, R., and Aleinikoff, J., 1985, Multiple thermal events in the Grenvillian orogenic cycle: *Geol. Soc. America Abstracts with Programs*, v. 17, p. 596.
- Gross, S.O., 1968, titaniferous ores of the Sanford Lake district, New York, in: *Ore Deposits of the United States, 1944-1967*, Vol. 1, The Graton-Sales Volume, Ridge, J.D. (ed), p. 140-154.
- Hargraves, R.B., 1969, A contribution to the geology of the Diana syenite gneiss complex, in: *Origin of anorthosites and related rocks*, Isachsen, Y.W. (ed): New York State Museum Memoir 18, p. 343-356.
- Hazlewood, A.M., 1987, Fe-Ti oxide/silicate equilibria in the granulite facies Stark and Diana Complexes, Adirondack Mountains, New York: MS Thesis, University of Wisconsin, Madison, 70 p.
- Heyn, T.; Weathers, M.S.; and Bird, J.M., 1987, Two mylonitization events, NW Adirondacks: *Geol. Soc. Amer. Abstracts with Programs*, 19, p. 702.
- Heyn, T., 1991, Tectonites of the northwest Adirondack Mts., NY: Structural and metamorphic evolution: Ph.D. thesis, Cornell University, Ithaca, NY, 203 p.
- Hills, F.A., and Isachsen, Y.W., 1975, Rb/Sr isochron date for mangeritic rocks from the Snowy Mountain massif, Adirondack highlands, and implications from initial ⁸⁷Sr/⁸⁶Sr: *Geol. Soc. Amer. Abstracts with Programs*, 7, p. 73-74.
- Hudson, M.R.; Grant, N.K.; Carl, J.D.; and Ambers, C.P., 1986, The timing of high grade metamorphism in the northwest Adirondacks: *Geol. Soc. Amer. Abstracts with Programs*, 18, p. 23-24.
- Isachsen, Y.W., 1969, Origin of anorthosite and related rocks - a summarization, in: *Origin of anorthosite and related rocks*, Isachsen, Y.W. (ed): New York State Museum Memoir 18, p. 435-445.
- _____, 1975, Possible evidence for contemporary doming of the Adirondack Mountains, New York, and suggested implications for regional tectonics and seismicity: *Tectonophysics*, 29, p. 169-181.
- _____, and Landing, E., 1983, First Proterozoic stromatolites from the Adirondacks: *Geol. Soc. Amer. Abstracts with Programs*, 15, p. 601.
- Jaffe, H.W., and Schumacher, J., 1985, Garnet and pyroxene exsolved from Al-rich orthopyroxene in the Marcy massif, Adirondacks: *Can. Mineral.*, v. 23, p. 457-478.
- _____; Robinson, P.; and Tracy, R.J., 1978, Orthoferrosilicate and other iron-rich pyroxenes in microperthite gneiss of the Mount Marcy area, Adirondack Mountains: *Amer. Mineral.*, 63, p. 1116-1136.
- Johnson, C.A., and Essene, E.J., 1982, The formation of garnet in olivine-bearing meta-gabbros from the Adirondacks: *Contrib. Min. Petrol.*, v. 72, p. 111-122.
- Katz, S., 1955, Seismic study of the crustal structure in Pennsylvania and New York: *Seism. Soc. America Bull.*, v. 45, p. 303-345.
- Kemp, J.F., 1920, Geology of the Mount Marcy Quadrangle: *New York State Museum Bull.*, 229-230, 86 p.
- _____, Ruedemann, R., 1910, Geology of the Elizabethtown and Port Henry quadrangles: *New York State Museum Bull.*, 138, 173 p.
- Kolker, A., 1982, Mineralogy and geochemistry of Fe-Ti oxide and apatite (Nelsonite) deposits and evaluation of the liquid immiscibility hypothesis: *Econ. Geol.*, v. 77, p. 1146-1158.
- Lamb, W., 1987, Metamorphic fluids and granulite genesis: Ph.D. Thesis, Univ. of Wisconsin, Madison, 234 p.
- _____, Brown, P.E., and Valley, J.W., 1991, Fluid inclusions in Adirondack granulites: Implications for the retrograde P-T path: *Contrib. Min. Pet.*, 107, p. 472-483.
- _____, and Valley, J.W., 1988, Granulite facies amphibole and biotite equilibria: The calculation of peak-metamorphic water activities in the Adirondack Mts., NY: *Contrib. Min. Petrol.*, v. 1200, p. 349-360.
- _____, and _____, 1984, Metamorphism of reduced granulites in low-CO₂ vapor-free environment: *Nature*, 312, p. 56-58.
- _____, and _____, 1985, C-O-H fluid calculations and granulite genesis, in: *The Deep Proterozoic Crust in the North Atlantic Provinces*, Tobi, A.C., and Touret, J.L.R. (eds): Reidel, Dordrecht, p. 119-131.
- _____; _____; and Brown, P.E., 1987, Post-metamorphic CO₂-rich fluid inclusions in granulites: *Contrib. Mineral. Petrol.*, 96, p. 485-495.
- Lattard, D., 1987, Subsolidus phase relations in the system Zr-Fe-Ti-O in equilibrium with metallic Fe: Implications for lunar petrology: *Contrib. Mineral. Petrol.*, v. 96, p. 485-495.
- Leonard, B., and Buddington, A.F., 1964, Ore deposits of the St. Lawrence County magnetite district, northwest Adirondacks, New York: U.S. Geol. Surv. Prof. Pap. 377, 259 p.
- Levin, S., 1950, Genesis of some Adirondack garnet deposits: *Geol. Soc., Amer. Bull.*, 61, p. 519-565.
- Lewis, J.R., 1969, Structure and stratigraphy of the Rossie Complex, northwest Adirondacks, New York: Ph.D. Thesis, Syracuse Univ., Syracuse, NY.
- Lindsley, D.H., 1983, Pyroxene thermometry: *Amer. Mineral.*, 68, p. 477-493.

- _____, 1991, Origin of Fe-Ti oxide deposits in the LAC: IGCP-290 Abstracts, Colgate Univ., Hamilton, NY, p. 5.
- Luther, F.R., 1976, The petrological evolution of the garnet deposit at Gore Mountain, Warren County, New York: Ph.D. thesis, Lehigh Univ.
- Mann, J., and Revetta, F.A., 1979, Geological interpretation of a detailed gravity survey of the anorthosite massif, Adirondack Mountains, New York: Geol. Soc. Amer. Abs. with Prog., v. 11, p. 43.
- Marcantonio, F.; McNutt, R.; Dickin, A.; and Heamen, L., 1990, Isotopic evidence for the crustal evolution of the Frontenac Arch in the Grenville Province of Ontario, Canada: Chem. Geol., v. 83, p. 297-314.
- Martignole, J., and Schrijver, K., 1970, Tectonic setting and evolution of the Morin anorthosite, Grenville Province, Quebec: Bull. Geol. Soc. Finland, 42, p. 165-209.
- McLelland, J., 1984, Origin of ribbon lineation within the southern Adirondacks, U.S.A.: Jour. Structural Geology, v. 6, p. 147-157.
- _____, 1986a, Pre-Grenvillian history of the Adirondacks as an anorogenic bimodal caldera complex of mid-Proterozoic age: Geology, 14, p. 229-233.
- _____, 1989, Crustal growth associated with anorogenic mid-Proterozoic anorthosite massifs in northeastern North America, in Ashwal, L., ed., Growth of Continental Crust: Tectonophysics, v. 161, p. 331-343.
- _____, 1990, Geology of the Adirondack portion of the Glens Falls 1°x2° Quadrangle, in Slack, J. (ed.), Summary Results of the Glens Falls CUSMAP Project, New York, Vermont, and New Hampshire: U.S. Geol. Surv. Bull. 1887, p. B1-B10.
- _____, 1991, The early history of the Adirondacks as an anorogenic, bimodal magmatic complex, in Perchuck, L., ed., Progress in Metamorphic and Magmatic Petrology, Cambridge University Press, p. 317-343.
- _____, and Chiarenzelli, J., 1990, Isotopic constraints on emplacement age of anorthositic rocks of the Marcy massif, Adirondack Mts., New York: Jour. Geology, v. 98, p. 19-41.
- _____, and _____, 1991, Geochronological studies in the Adirondack Mountains and the implications of a middle Proterozoic tonalitic suite, in Gower, C.; Rivers, T.; and Ryan, B., eds., Mid-Proterozoic geology of the southern margin of Laurentia-Baltica: Geol. Assoc. Canada Spec. Paper 38, p. 175-194.
- _____, Hansen, E.; and Hunt, W., 1988, The relationship between marble and metamorphic charnockite near Speculator, central Adirondacks, New York: Jour. Geol., v. 96, p. 455-467.
- _____, and Husain, J., 1986, Nature and timing of anatexis in the eastern and southern Adirondack highlands, Jour. Geology, v. 94, p. 17-25.
- _____, and Isachsen, Y., 1985, Geological evolution of the Adirondack Mountains: a review, in Tobl, A.C. and Touret, J.L.R. (eds), The deep Proterozoic Crust in the North Atlantic provinces: Reidel, p. 175-215.
- _____, and _____, 1986, Synthesis of geology of the Adirondack Mountains, New York, and their tectonic setting within the southwestern Grenville Province, in Moore, J.M.; Davidson, A.; and Baer, A., eds., The Grenville Province: Geol. Assoc. Canada Spec. Paper 31, p. 75-94.
- _____, and Joseph, G., 1991, Origin of the Sacandaga Fm., Adirondack Highlands, N.Y.: Geol. Soc. Am. Abs. with Programs, v. 23, p. A102.
- _____, and Whitney, P., 1977, The origin of garnet in the anorthosite-charnockite suite of the Adirondacks: Contrib. Mineral. Petrol., v. 60, p. 161-181.
- _____, and Whitney, P., 1990, Anorogenic, bimodal emplacement of the anorthosite-mangerite-charnockite-granite suite of the Adirondack Mountains, New York, in Stein, H., and Hannah, J., eds., Proterozoic Mineral Deposits and their relationship to magmatism: Geol. Soc. America Special Paper, v. 246, p. 301-315.
- _____, Chiarenzelli, J.; and Perham, A., 1991a, Age, field, and petrological relationships of the Hyde School Gneiss: A re-examination of geologic history in the Adirondack lowlands, New York: Jour. Geol., v. 100, p. 69-90.
- _____, Daly, J.S.; and Chiarenzelli, J., 1991b, Geologic and isotopic constraints on relationships between the Adirondack highlands and lowlands: Jour. Geol. (in press).
- _____, Lochhead, A.; and Vynhal, C., 1987, Evidence for multiple metamorphic events in the Adirondack Mts., N.Y.: Jour. Geology, v. 96, p. 279-298.
- _____, Chiarenzelli, J.; Whitney, P.; and Isachsen, Y., 1988, U-Pb geochronology of the Adirondack Mountains and implications for their geologic evolution: Geology, v. 16, p. 920-924.
- Menuge, J., and Daly, J.S., 1991, Proterozoic evolution of the Erris Complex, NW Mayo, Ireland: neodymium isotope evidence, in Gower, C., Rivers, T., and Ryan, B., eds., Mid-Proterozoic geology of the southern margin of Laurentia-Baltica: Geol. Assoc. Canada Spec. Pap. (in press).
- Mezger, K., 1990, Geochronology in granulites, in Vielzeuf, D., and Vidal, Ph., eds., Granulites and Crustal Evolution: Kluwer Academic Publishers, p. 451-470.
- _____, Rawnsley, C.; Bohlen, S.; and Hanson, G., 1990, U-Pb garnet, sphene, monazite, and rutile ages: Implications for the duration of high grade metamorphism and cooling histories, Adirondack Mts., New York: Jour. Geol., v. 99, p. 415-428.
- _____, Hanson, G.N.; and Bohlen, S.R., 1988, Garnet U/Pb systematics: Dating the polymetamorphic history of the Achean Plkwitonei granulite domain and the Cross Lake subprovince, Manitoba, Canada: Contrib. Mineral. Petrol.
- Moore, J., and Thompson, P., 1980, The Flinton Group: A late Precambrian metasedimentary succession in the Grenville Province of eastern Ontario: Can. Jour. Earth Sci., v. 17, p. 1685-1707.
- Morrison, J., 1988, Petrology and stable isotope geochemistry of the Marcy anorthosite massif, Adirondack Mountains, New York, Ph.D. Thesis, Univ. of Wisconsin-Madison, 194 p.
- _____, 1991, Compositional constraints on incorporation of Ca into amphiboles: Am. Mineral., 75, p. 1920-1930.
- _____, and Valley, J., 1988, Contamination of the Marcy anorthosite massif, Adirondack Mountains, NY: petrologic and isotopic evidence: Contrib. Mineral. Petrol., v. 98, p. 97-108.
- _____, and _____, 1988b, Post-granulite facies fluid infiltration in the Adirondack Mountains: Geology, v. 16, p. 513-516.
- Morse, S.A., 1969, Layered intrusions and anorthosite genesis, in Isachsen, Y.W. (ed.), Origin of Anorthosite and related rocks: New York State Museum Memoir 18, p. 175-188.
- Murphy, J.E., and Ohle, E.L., 1968, The Iron Mountain Mine, Iron Mountain, Missouri, in Ridge, J.D. (ed.), Ore Deposits in the United States, 1933-1967, Vol. 1, The Graton-Sales Volume, p. 287-302.
- Newton, R.C., and Haselton, H.T., 1981, Thermodynamics of the garnet-plegionoclase-Al₂SiO₅-quartz geobarometer, in Newton, R.C.; Navrotsky, A.; and Wood, B.J. (eds.), Thermodynamics of minerals and melts: New York, Springer Verlag, p. 129-145.
- Ollila, P.W.; Haffe, H.W.; and Jaffe, E.B., 1984, Iron-rich inverted pigeonite: evidence for deep emplacement of the Adirondack anorthosite massif: Geol. Soc. Amer. Abs. with Prog., 16, p. 54.
- Olsen, J., and Morse, S.E., 1991, Anorthositic, Al-Fe magmas, and the enriched mantle signal: IGCP-290 Abstracts, Colgate Univ., Hamilton, NY, p. 6.
- Palmer, D.F., 1970, Geology and ore deposits near Benson Mines, New York: Econ. Geol., 65, p. 31-39.
- Patchett, J., and Ruiz, J., 1990, Nd isotopes and the origin of the Grenville-age rocks in Texas: Implications for the Proterozoic evolution of the United States, mid-continent region: Jour. Geology, v. 97, p. 685-696.
- Pearce, J.; Harris, N.; and Tindle, A., 1984, Trace element discrimination diagrams for the tectonic interpretation of granitic rocks: Journal Petrology, v. 25, p. 956-983.
- Postel, A.W., 1952, Geology of the Clinton County magnetite district, New York: U.S. geol. Surv. Prof. Paper, 237, 88 p.
- Powers, R.E., and Bohlen, S.R., 1985, The role of synmetamorphic igneous rocks in the metamorphism and partial melting of metasediments, NW Adirondacks: Contrib. Mineral. Petrol., 90, p. 401-409.
- Putnam, G.W., and Sullivan, J.W., 1979, Granitic pegmatites as estimators of crustal pressures - a test in the eastern Adirondacks, New York: Geology, 7, p. 549-553.
- _____, and Young, J.R., 1985, The bubbles revisited: the geology and geochemistry of "Saratoga" mineral waters: Northeastern Geology, 7, p. 1-25.
- Ratcliffe, N., and Aleinikoff, J., 1990, Speculations on the structural chronology and tectonic setting of Middle Proterozoic terranes of the northern U.S. Appalachians based on U-Pb dating, field relationships, and geochemistry: Geol. Soc. America Abstracts with Programs, v. 22, p. 64.
- Rawnsley, C.; Bohlen, S.; and Hanson, G., 1987, Constraints on the cooling history of the Adirondack Mts.: U-Pb investigation of metamorphic sphene: EOS (Transactions American Geophysical Union), v. 68, no. 44, p. 1515.
- Rumble, D.S., and Spear, F.S., 1983, Oxygen isotope equilibration and permeability enhancement during regional metamorphism: Jour. Geol. Soc. 140, p. 619-628.
- Seal, T.L., 1986, Pre-Grenville dehydration metamorphism in the Adirondack Mountains, New York: Evidence from pelitic and semipelitic metasediments, M.S. thesis, State Univ. of New York at Stony Brook.
- Sharp, Z.D.; Essene, E.J.; Anovitz, L.M.; Metz, G.W.; Westrum, E.F.; Hemingway, B.S.; and Valley, J.W., 1986, The heat capacity of natural monticellite and phase equilibria in the system CaO-MgO-SiO₂-CO₂: Geochim. Cosmochim. Acta, 49, p. 1475-1484.
- Shieh, Y.N., 1985, High $\delta^{18}\text{O}$ granitic plutons from the Frontenac Axis, Grenville Province of Ontario, Canada: Geochim. Cosmochim. Acta, 49, p. 117-123.
- Silver, L., 1969, A geochronological investigation of the anorthosite complex, Adirondack Mts., New York, in Isachsen, Y., ed., Origin of anorthositic and related rocks: N.Y. State Mus. Mem. 18, p. 233-252.
- Simmons, E.C., and Hanson, G.N., 1978, Geochemistry and origin of massif-type anorthositic: Contrib. Mineral. Petrol., 66, p. 119-135.
- Simmons, E.C., 1964, Gravity survey and geological interpretation, northern New York: Geol. Soc. Amer. Bull., 75, p. 81-98.
- Steiger, R.H., and Jager, E., 1977, Subcommittee on geochronology: Commission on the use of decay constants in geo- and cosmochronology: Earth and Planet. Sci. Letters, 36, p. 359-362.
- Smyth, C.H., and Buddington, A.F., 1926, Geology of the Lake Bonaparte Quadrangle: New York State Museum Bull., 269, 102 p.
- Tewksbury, B., and Kirby, E., 1992, Shear fabric development in leucogranitic gneisses of the Payne Lake and Dodds Creek bodies, Muskellunge Lake

- quadrangle, New York: Geol. Soc. Am. Abs. with Prog. v. 24, p. 80.
- Tracy, R.J.; Jaffe, H.W.; and Robinson, P., 1978, Monticellite marble at Cascade Mountain, Adirondack Mountains, New York: *Am. Mineral.*, 63, p. 991-999.
- Valley, J., 1985, Polymetamorphism in the Adirondacks, in: *Tobl, A., and Touret, J., eds., The Deep Proterozoic Crust in the North Atlantic Provinces*, NATO ASI Series V. 158: D. Reidel Publ. Co., p. 217-236.
- _____, 1986, Stable isotope geochemistry of metamorphic rocks, in: *Valley, J.W.; Taylor, H.P.; and O'Neill, J.R. (eds.), Stable isotopes in high temperature geological processes: Mineral. Soc. Amer. Reviews*, 16, p. 445-490.
- _____, 1991, Granulite formation is driven by magmatic processes in the deep crust: *Earth Sci. Rev.*, 32, p. 145-146.
- _____, Bohlen, S.R.; Essene, E.J.; and Lamb, W., 1990, Metamorphism in the Adirondacks. II. The Role of Fluids: *Jour. Petrol.*, v. 31, pt. 3, p. 555-596.
- _____, and Essene, E., 1980, Calc-silicate reactions in Adirondack marbles: The role of fluids and solid solutions: *Bull. Geol. Soc. America*, v. 91, p. 114-117.
- _____; _____; and Peacor, D.R., 1983, Fluorine-bearing garnets in Adirondack calc-silicates: *Amer. Mineral.*, 68, p. 444-448.
- _____, and Graham, C.M., 1991, Ion microprobe analysis of oxygen isotope ratios in metamorphic magnetite-diffusion equilibration and implications for thermal history: *Contrib. Min. Petrol.*, 109, p. 38-52.
- _____, and O'Neill, J.R., 1979, Limitations on anorthosite-metasediment fluid exchange during granulite facies metamorphism in the Adirondacks: *Geol. Soc. Amer. Abs. with Prog.*, 11, p. 531.
- _____, and _____, 1981, $^{13}\text{C}/^{12}\text{C}$ exchange between calcite and graphite: a possible geothermometer in Grenville marbles: *Geochim. Cosmochim. Acta*, 45, p. 411-419.
- _____; McLelland, J.; Essene, E.; and Lamb, W., 1983, Metamorphic fluids in the deep crust: evidence from the Adirondacks: *Nature*, v. 301, p. 227-228.
- _____; Peterson, E.U.; and Bowman, J.R., 1982, Fluorophlogopite and fluorremolite in Adirondack marbles and calculated C-O-H-F compositions: *Amer. Mineral.*, 67, p. 545-557.
- van der Pluijm, B., and Carlson, K., 1989, Extension in the Central Metasedimentary Belt of the Ontario Grenville: Timing and tectonic significance: *Geology*, v. 17, p. 161-164.
- Van Diver, B., 1976, *Rocks and Routes of the North Country*: W.F. Humphrey Press, 205 p.
- Veizer, J., and Hoefs, J., 1976, The nature of the $^{18}\text{O}/^{12}\text{C}$ secular trends in sedimentary carbonate rocks: *Geochim. Cosmochim. Acta*, 40, p. 1387-1395.
- Walton, M., and deWaard, D., 1963, Orogenic evolution of the Precambrian in the Adirondack highlands, a new synthesis: *Koninkl. Nederl. Akad. Van Wetenschappen, Ser. B.*, v. 66, p. 98-106.
- Watson, E.B., and Harrison, T.M., 1983, Zircon saturation revisited: temperature and composition effects in a variety of crustal magma types: *Earth and Planet. Sci. Letters*, 64, p. 295-304.
- Weis, P.L.; Friedman, I.; and Gleason, J.P., 1981, The origin of graphite: evidence from isotopes: *Geochim. Cosmochim. Acta*, 45, p. 2325-2332.
- Whelan, J.F.; Rye, R.O.; and deLorraine, W.F., 1984, The Balmat-Edwards zinc-lead deposits: syndimentary ore from Mississippi Valley-type fluids: *Economic Geology*, 79, p. 239-265.
- White and Chappell, 1983, Granitoid types and their distribution in the Lachlan fold belt, southeastern Australia, in: *Roddick, J., ed., Circum-Pacific plutonic terranes: Geol. Soc. America Mem.* 159, p. 21-34.
- Whitney, P.R., 1972, Spinel inclusions in plagioclase of metagabbros from the Adirondack highlands: *Amer. Mineral.*, 57, p. 1429-1436.
- _____, 1983, A three-stage model for the tectonic history of the Adirondack region, New York: *Northeastern Geol.*, 5, p. 61-72.
- _____, 1986, Geochemistry of Proterozoic granitoids from the western Adirondacks, New York State: *Geol. Soc. Amer. Abstr. with Programs*, 18, p. 788.
- _____, and Davin, M.T., 1987, Taconic deformation and metasomatism in Proterozoic rocks of the eastern most Adirondacks: *Geology*, 15, p. 500-503.
- _____, and Olmsted, J., 1989, Geochemistry of albite gneisses, northeastern Adirondacks, N.Y.: *Contrib. Mineral. Petrol.*, v. 99, p. 476-484.
- Wiener, R.W., 1981, Structural geology and petrology of bedrock along the Adirondack highlands-northwest lowlands boundary near Harrisville, N.Y., Ph.D. thesis, Univ. of Massachusetts, Amherst, 163 p.
- _____; McLelland, J.M.; Isachsen, Y.W.; and Hall, L.M., 1984, Stratigraphy and structural geology of the Adirondack Mountains, New York: Review and Synthesis, in: *Bartholome, M.J. (ed.), The Grenville Event in the Appalachians and related topics: Geol. Soc. America Spec. Paper* 194, p. 1-55.
- Wynne-Edwards, H.R., 1972, The Grenville Province, in: *Price, R.A. and Douglas, R.J.W. (eds.), Variations in tectonic styles in Canada: Geol. Assn. of Canada Spec. Paper* 11, p. 264-334.
- Zeltz, I., and Gilbert, F.P., 1981, Aeromagnetic map of New York, Adirondack Mountains sheet: U.S. Geol. Surv. Geophys. Inv. Map GP-938, Sheet 5 of